

# TEST REPORT



Report. No.: TCT-TR01-221125-7

Date: 2022-11-25



Page: 1 of 61 pages

<b>TEST REPORT</b> <b>EN 60947-5-1</b> <b>Part 5: Control circuit devices and switching elements</b> <b>Electromechanical control circuit devices</b>	
<b>Report Number.....</b>	TCT-TR01-221125-7
<b>Date of issue.....</b>	2022-11-25
<b>Total number of pages .....</b>	61 pages
<b>Name of Testing Laboratory preparing the Report .....</b>	Tyger CT Corp. / #818, BUILDING B, DONGTAN KUMGANG PENTERIUM IX TOWER 27, DONGTANCHEOMDANSANEOP 1- RO HWASEONG-SI Republic of Korea
<b>Applicant's name .....</b>	KG Auto Co., Ltd.
<b>Address.....</b>	45, Sojeongsandan 4-ro, Sojeong-myeon, Sejong-si, Republic of Korea
<b>Test specification:</b>	
<b>Standard.....</b>	EN 60947-5-1:2017 + AC:2020-05
<b>Test procedure .....</b>	CE LVD
<b>Non-standard test method .....</b>	N/A
<b>Test Report Form No. ....</b>	IEC60947_5_1H
<b>Test Report Form(s) Originator .....</b>	DEKRA Certification B.V.
<b>Master TRF.....</b>	Dated 2020-12-18
<b>Copyright © 2020 IEC System of Conformity Assessment Schemes for Electrotechnical Equipment and Components (IECEE System). All rights reserved.</b>	
This publication may be reproduced in whole or in part for non-commercial purposes as long as the IECEE is acknowledged as copyright owner and source of the material. IECEE takes no responsibility for and will not assume liability for damages resulting from the reader's interpretation of the reproduced material due to its placement and context.	
If this Test Report Form is used by non-IECEE members, the IECEE/IEC logo and the reference to the CB Scheme procedure shall be removed.	
<b>This report is not valid as a CB Test Report unless signed by an approved IECEE Testing Laboratory and appended to a CB Test Certificate issued by an NCB in accordance with IECEE 02.</b>	

# TEST REPORT

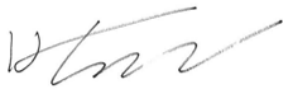

Report. No.: TCT-TR01-221125-7  
 Date: 2022-11-25  
 Page: 2 of 61 pages

<b>Test item description</b> ..... :	Sign Tower (Indicating Tower)	
<b>Trade Mark</b> ..... :		
<b>Manufacturer</b> .....	KG Auto Co., Ltd.	
<b>Model/Type reference</b> .....	KG-Sxy-V2-zL	
	x = F: flickering, or blank: no flickering;	
	y = B: buzzer, or blank: no buzzer;	
	z = 1, or 2, or 3, or 4, or 5: installed lamp number	
<b>Ratings</b> .....	AC 220 V, 50/60 Hz, 7.1 W max.	
<b>Responsible Testing Laboratory (as applicable), testing procedure and testing location(s):</b>		
<input checked="" type="checkbox"/>	<b>CB Testing Laboratory:</b>	Tyger CT Corp.
	<b>Testing location/ address</b> ..... :	#818, Building B, Dongtan Kumgang Penterium IX Tower, 27, Dongtancheomdansaneop 1-ro, Hwaseong-si, Gyeonggi-do, Korea
	<b>Tested by (name, function, signature)</b> ..... :	SeonGwang Kim <span style="float: right;"></span>
	<b>Approved by (name, function, signature)</b> ... :	SungMarn Park <span style="float: right;"></span>
<input type="checkbox"/>	<b>Testing procedure: CTF Stage 1:</b>	N/A
	<b>Testing location/ address</b> ..... :	
	<b>Tested by (name, function, signature)</b> ..... :	
	<b>Approved by (name, function, signature)</b> ... :	
<input type="checkbox"/>	<b>Testing procedure: CTF Stage 2:</b>	N/A
	<b>Testing location/ address</b> ..... :	
	<b>Tested by (name + signature)</b> ..... :	
	<b>Witnessed by (name, function, signature) . :</b>	
	<b>Approved by (name, function, signature)</b> ... :	
<input type="checkbox"/>	<b>Testing procedure: CTF Stage 3:</b>	N/A
<input type="checkbox"/>	<b>Testing procedure: CTF Stage 4:</b>	N/A
	<b>Testing location/ address</b> ..... :	
	<b>Tested by (name, function, signature)</b> ..... :	
	<b>Witnessed by (name, function, signature) . :</b>	
	<b>Approved by (name, function, signature)</b> ... :	
	<b>Supervised by (name, function, signature) :</b>	

# TEST REPORT



Report. No.: TCT-TR01-221125-7

Date: 2022-11-25

Page: 3 of 61 pages

<b>List of Attachments (including a total number of pages in each attachment):</b>		
<b>Document No.</b>	<b>Documents included / attached to this report (description)</b>	<b>Page No.</b>
Table	Critical components information	54
Appendix 1	Block diagram	56
Appendix 2	Circuit diagram	57
Appendix 3	Layout	58
Appendix 4	photographs	59 - 61
<b>Summary of testing:</b> This report may consist of more than one report and is only valid with additional or previous issued reports:  Report Ref. No : SR-13-0220		
<b>Tests performed (name of test and test clause):</b> Related all clauses	<b>Testing location:</b> Tyger CT Corp. / #818, BUILDING B, DONGTAN KUMGANG PENTERIUM IX TOWER 27, DONGTANCHEOMDANSANEOP 1- RO HWASEONG-SI Republic of Korea	
<b>Summary of compliance with National Differences (List of countries addressed):</b>  <input checked="" type="checkbox"/> <b>The product fulfils the requirements of <u>EN 60947-5-1 : 2017</u> (insert standard number and edition and delete the text in parenthesis, leave it blank or delete the whole sentence, if not applicable)</b>		
<b>Statement concerning the uncertainty of the measurement systems used for the tests</b> (may be required by the product standard or client)  <input type="checkbox"/> <b>Internal procedure used for type testing through which traceability of the measuring uncertainty has been established:</b> <b>Procedure number, issue date and title:</b>  Calculations leading to the reported values are on file with the NCB and testing laboratory that conducted the testing.  <input checked="" type="checkbox"/> <b>Statement not required by the standard used for type testing</b>  (Note: When IEC or ISO standard requires a statement concerning the uncertainty of the measurement systems used for tests, this should be reported above. The informative text in parenthesis should be delete in both cases after selecting the applicable option)		

# TEST REPORT

















Report. No.: TCT-TR01-221125-7

Date: 2022-11-25

Page: 4 of 61 pages

**Copy of marking plate:**

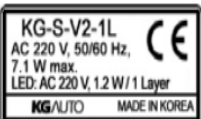
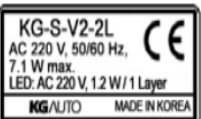
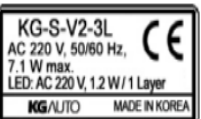
The artwork below may be only a draft. The use of certification marks on a product must be authorized by the respective NCBs that own these marks.

Flashing	Buzzer	Lamp Layer				
		1	2	3	4	5
0	0	 <p style="text-align: center;">KG-SFB-V2-1L</p>	 <p style="text-align: center;">KG-SFB-V2-2L</p>	 <p style="text-align: center;">KG-SFB-V2-3L</p>	 <p style="text-align: center;">KG-SFB-V2-4L</p>	 <p style="text-align: center;">KG-SFB-V2-5L</p>
0	X	 <p style="text-align: center;">KG-SF-V2-1L</p>	 <p style="text-align: center;">KG-SF-V2-2L</p>	 <p style="text-align: center;">KG-SF-V2-3L</p>	 <p style="text-align: center;">KG-SF-V2-4L</p>	 <p style="text-align: center;">KG-SF-V2-5L</p>
X	0	 <p style="text-align: center;">KG-SB-V2-1L</p>	 <p style="text-align: center;">KG-SB-V2-2L</p>	 <p style="text-align: center;">KG-SB-V2-3L</p>	 <p style="text-align: center;">KG-SB-V2-4L</p>	 <p style="text-align: center;">KG-SB-V2-5L</p>
X	X	 <p style="text-align: center;">KG-S-V2-1L</p>	 <p style="text-align: center;">KG-S-V2-2L</p>	 <p style="text-align: center;">KG-S-V2-3L</p>	 <p style="text-align: center;">KG-S-V2-4L</p>	 <p style="text-align: center;">KG-S-V2-5L</p>

# TEST REPORT



Report. No.: TCT-TR01-221125-7

Date: 2022-11-25

Page: 5 of 61 pages

Test item particulars .....	Sign Tower (Indicating Tower)
Classification of installation and use .....	See below
Supply Connection.....	AC 220 V, 50/60 Hz, 7.1 W max.
Kind of control circuit device.....	<input type="checkbox"/> manual control switches, e.g. push-buttons, rotary switches, foot switches, etc. <input type="checkbox"/> electromagnetically operated control switches, either time delayed or instantaneous, e.g. contactor relays <input type="checkbox"/> pilot switches, e.g. pressure switches, temperature sensitive switches (thermostats) <input type="checkbox"/> position switches <input checked="" type="checkbox"/> associated control equipment, e.g. indicator lights, etc.
Kind of switching elements.....	No switching element <input type="checkbox"/> auxiliary contacts of a switching device (e.g. contactor, circuit-breaker, etc) which are not dedicated exclusively for use with the coil of that device <input type="checkbox"/> interlocking contacts of enclosure doors <input type="checkbox"/> control circuit contacts of rotary switches <input type="checkbox"/> control circuit contacts of overload relays
Number of poles.....	Maximum five external poles
Kind of current.....	<input checked="" type="checkbox"/> ac and/or <input type="checkbox"/> dc
Interrupting medium.....	<input type="checkbox"/> air, <input type="checkbox"/> oil, <input type="checkbox"/> gas, <input type="checkbox"/> vacuum, <input checked="" type="checkbox"/> external PLC
Operating conditions.....	See below
Method of operations.....	<input checked="" type="checkbox"/> manual <input type="checkbox"/> electromagnetic <input type="checkbox"/> pneumatic <input type="checkbox"/> electro-pneumatic
Method of control.....	<input checked="" type="checkbox"/> automatic <input type="checkbox"/> non-automatic <input type="checkbox"/> semi-automatic

# TEST REPORT

Report. No.: TCT-TR01-221125-7

Date: 2022-11-25

Page: 6 of 61 pages



Rated and limiting values for switching elements:	N/A
Voltages:	
- rated operational voltage $U_e$ (V) .....	220 V a.c.
- rated insulation voltage $U_i$ (V) .....	220 V a.c.
- rated impulse withstand voltage $U_{imp}$ (kV) .....	N/A
Currents:	
- conventional free air thermal current $I_{th}$ (A) .....	N/A
- conventional enclosed thermal current $I_{the}$ (A) .....	N/A
- rated operational current $I_e$ (A) .....	42 mA
Rated frequency (Hz) .....	50/60
Utilization category .....	N/A
Short-circuit characteristic:	
- rated conditional short-circuit current (kA) .....	N/A
- kind of protective device .....	5x20 mm 1AL250V; external current fuse
Electrically separated contact elements .....	N/A (stated by manufacturer)
Actuating quantities for pilot switches .....	N/A
Pilot switches having two or more contact elements ...	N/A
Indication of contact elements of same polarity .....	N/A
IP code, in case of an enclosed control device .....	IP20
Pollution degree .....	3
Suitability for isolation, with the symbol 07-13-06 of IEC 60617-7 .....	N/A

# TEST REPORT



Report. No.: TCT-TR01-221125-7  
Date: 2022-11-25  
Page: 7 of 61 pages

**Possible test case verdicts:**

- test case does not apply to the test object..... : N/A
- test object does meet the requirement..... : P (Pass)
- test object does not meet the requirement..... : F (Fail)

Testing..... :

Date of receipt of test item ..... : 2022-08-01

Date (s) of performance of tests ..... : 2022-08-01 ~ 2022-11-11

**General remarks:**

The test results presented in this report relate only to the object tested.

This report shall not be reproduced, except in full, without the written approval of the Issuing testing laboratory.

"(See Enclosure #)" refers to additional information appended to the report.

"(See appended table)" refers to a table appended to the report.

Throughout this report a  comma /  point is used as the decimal separator.

**Manufacturer's Declaration per sub-clause 4.2.5 of IEC60947-5-1:**

The application for obtaining a CB Test Certificate includes more than one factory location and a declaration from the Manufacturer stating that the sample(s) submitted for evaluation is (are) representative of the products from each factory has been provided .....

- Yes
- Not applicable

**When differences exist; they shall be identified in the General product information section.**

Name and address of factory (ies) .....

**General product information and other remarks:**

This sign tower is designed as an indicating tower with five layers of LED light assembled, which is installed on a machine to indicate its condition with safety colour of visual lights in addition to flashing lights and buzzer.

## TEST REPORT

Report. No.: TCT-TR01-221125-7

Date: 2022-11-25

Page: 8 of 61 pages



<b>5</b>	<b>PRODUCT INFORMATION</b>		P
5.2	Marking		P
	Data shall be preferably marked on the equipment:		P
	a - manufacturer's name or trademark	Both of all on the marking plate	P
	b - type designation or serial number	Model name on the marking plate	P
	Data shall be included on the nameplate, or on the equipment, or in the manufacturer's published literature:		-
	c - number of this standard	EN 60947-5-1; in the leaflet	P
	d - rated operational voltages	On the marking plate	P
	e - utilization category and rated operational currents, at the rated operational voltages of the control circuit device	On the marking plate	P
	f - rated insulation voltage:	In the leaflet	P
	g - rated impulse withstand voltage		N/A
	h – vacant		N/A
	l – IP code, in case of enclosed control circuit device	IP20	P
	j – pollution degree	3	P
	k – type and maximum ratings of short-circuit protective device	5x20 mm T1AL250V; cartridge type of current fuse, written in the leaflet	P
	l - conditional short-circuit current		N/A
	m - suitability for isolation, where applicable, with the symbol S00288 of IEC 60617		N/A
	n - indication of contact elements of same polarity		N/A
	Marking of data under n) shall be included on the nameplate of the control circuit device in order to ensure proper wiring at installation.		N/A
	o) length of insulation to be removed before insertion of the conductor into the terminal.		N/A
	p) for non-universal screwless terminals: – "s" or "sol" for terminals declared for rigid-solid conductors; – "r" for terminals declared for rigid (solid and stranded) conductors; – "f" for terminals declared for flexible conductors.		N/A
	The indication "s", "sol", "r" or "f" for non-universal screwless terminals shall be marked on the device or, if the space available is not sufficient, on the smallest package unit or in technical information provided with the product.		N/A
5.2.2	Terminal identification and marking (see 7.1.8.4 of IEC 60947-1)		-



# TEST REPORT



Report. No.: TCT-TR01-221125-7

Date: 2022-11-25

Page: 9 of 61 pages

	Clearly and permanently identified according IEC 60445 and Annex L, unless superseded by relevant standard.	L.2.4	P
	Neutral terminal identified by letter ..... : ..... :	N	P
	Protective earth terminal identified by letter	No PE	N/A
5.2.3	Functional markings		N/A
	Actuators may be identified by symbols in the form of engravings, but if a stop button carries any symbol engraved or marked this symbol shall be a circle or oval		N/A
	Letters or words may be used where space is available		N/A
	Symbols shall be in accordance with IEC 60417		N/A
5.2.4	Emergency stop		N/A
	Actuator shape and colour, background colour and direction of unlatching for emergency stop devices with mechanical latching function shall be in accordance with 4.2 of IEC 60947-5-5		N/A
5.2.5	Operating diagram		N/A
5.2.5.1	General		-
	As rotary switches may have multiplicity of contacts elements and a multiplicity of actuator positions, it necessary that the manufacturer indicates the relationship between the actuator positions and the associated contact elements position		N/A
	The position indication shall be clear, and the associated text or symbols shall be indelible and easily legible		N/A
5.2.5.3	Terminal markings for operating diagrams		N/A
	Terminal markings shall be clearly identifiable with respect to the operating diagram (see also Annex M)		N/A
5.2.6	Time delay markings	No such a function	N/A
	The manufacturer shall indicate, for each time-delay contact element, the characteristic of the delay, according to 2.4.1.1 or 2.4.1.2		N/A
5.3	Instructions for installation, operation and maintenance		P
	The manufacture shall specify, in his documents or catalogues:	See below	P
	- the conditions for installation, operation and maintenance, if any, of the equipment during operation and after a fault		P
	- the specify the measures to be taken with regard to EMC, if any,	See test report of EMC-CE-4394.	N/A

# TEST REPORT

Report No.: TCT-TR01-221125-7  
 Date: 2022-11-25  
 Page: 10 of 61 pages



	- equipment only suitable in environment A shall provided with the following notice	<b>NOTICE</b> This product has been designed for environment B may cause unwanted electromagnetic disturbances in which case the user may be required to take adequate mitigation measures.	N/A
	- if necessary, the instructions for transport, installation and operation of the equipment shall indicate the measures that are particular importance for the proper and correct installation, commissioning and operation of the equipment.		N/A

<b>6</b>	<b>Normal service, mounting and transport conditions</b>		<b>P</b>
6.1.1	Ambient temperature		<b>P</b>
	Ambient air temperature does not exceed +40 °C and its average over 24 hours does not exceed +35°C and the lower limit is -5°C	0 to 40°C	<b>P</b>
6.1.2	Altitude		<b>-</b>
	Altitude of side of installation does not exceed 2000m	Up to 2 000 m	<b>P</b>
6.1.3	Atmospheric conditions		<b>-</b>
6.1.3.1	Relative humidity does not exceed 50 % at max temp +40 °C, higher rel. hum may at lower temperatures e.g. 90% at +20 °C	90 % R.H. @ 30°C	<b>P</b>
6.1.3.2	Pollution degree		<b>P</b>
	Unless otherwise stated, equipment for: - industrial use shall have a degree 3, depending upon micro-environment - household and similar shall have degree 2	3	<b>P</b>
6.1.4	Shock and vibration		<b>N/A</b>
	Under consideration		<b>N/A</b>
6.2	Conditions during transport and storage		<b>N/A</b>
	Under consideration		<b>N/A</b>
6.3	Mounting		<b>P</b>
	According manufacturer's instruction	See the leaflet for instructions.	<b>P</b>
6.3.1	Mounting of single hole mounted devices		<b>N/A</b>
	Dimensions according Table 2		<b>N/A</b>
6.3.1.1	Location of key recess (if any)		<b>N/A</b>
	Dimensions according Table 3		<b>N/A</b>
6.3.1.2	Range of panel thickness		<b>N/A</b>
	The device shall be capable of being mounted on any thickness between 1 and 6 mm		<b>N/A</b>
6.3.1.3	Grouping of devices		<b>N/A</b>

# TEST REPORT



Report No.: TCT-TR01-221125-7

Date: 2022-11-25

Page: 11 of 61 pages

	The distances a between the mounting centres in the same row and b between the centre lines of the rows shall be not less than those given in table 3. Distances a and b may be interchanged		N/A
--	--	--	-----

7	CONSTRUCTIONAL AND PERFORMANCE REQUIREMENTS		P
7.1	Constructional requirements		-
7.1.1	General		-
	Sub clause 7.1 of IEC 60947-1 applies except for 7.1.2, 7.1.3, 7.1.7, 7.1.9 and 7.1.13, and with the following additions:		-
7.1.2	Materials		P
7.1.3	Current-carrying parts and their connection		P
	No contact pressure through insulating materials		P
7.1.4	Clearances and creepage distances		P
	Clause 7.1.4 of IEC 60947-1 applies		N/A
	Clearances		-
	Minimum values are given in Table 13 and Table 15 of IEC 60947-1		N/A
	Rated impulse withstand voltage	See test sequence I	N/A
	Minimum clearance - Case B (mm)	Required :..... mm	N/A
	Minimum clearance - Case A (mm)	Required :..... mm	N/A
	Measured clearances (mm) .....	Measured :..... mm	N/A
	Creepage distances		-
	Pollution degree .....		N/A
	Comparative tracking index (V) .....		N/A
	Material group .....		N/A
	Rated insulation voltage $U_i$ (V) .....		N/A
	Minimum creepage distances (mm) .....		N/A
	Measured creepage distances (mm) .....		N/A
7.1.5	Actuator	No actuator provided	N/A
7.1.5.1	Insulation		N/A
	Clause 7.1.5.1 of IEC 60947-1 applies		-
7.1.5.2	Direction		N/A
	Clause 7.1.5.2 of IEC 60947-1 applies		-
7.1.5.3	Actuating force (or moment)	initial: full load:	N/A
		See test sequence V	-
7.1.5.4	Limitation of rotation (of rotary switch)		N/A

## TEST REPORT

Report. No.: TCT-TR01-221125-7

Date: 2022-11-25

Page: 12 of 61 pages



	When actuators with limited or unidirectional movement are used, they shall be fitted with robust means of limitation, capable of withstanding five times the actual maximum actuating moment.		-
7.1.5.5	Emergency stop		N/A
	The actuator shall preferably latch in the actuated position with the control contact open. This latching shall be released by a separate action, e.g. by pulling, rotation, or by means of a key.		-
7.1.6	Indication of the contact position		N/A
	Clause 7.1.6 of IEC 60947-1 applies		-
7.1.7	Conditions for control switches suitable for isolation		N/A
	A control switch suitable for isolation shall be manually operated with a direct opening action (see Annex K) and shall comply with the isolating function in the open position (see 2.1.19 and 7.1.7 of IEC 60947-1).		-
	The open position of a control switch suitable for isolation shall be a position in which the switch can remain when no actuating force is applied.		-
	In order to avoid unintentional reclosing, it shall be possible to prevent the operation of the control switches suitable for isolation when the contact elements are in the open position. This may be obtained by padlocking or by a latch which shall only be releasable by a special tool or key.		-
7.1.8	Terminals		-
		See clause 8.2.4	-
7.1.10	Provisions for protective earthing		-
	Clause 7.1.10 of IEC 60947-1 applies		-
7.1.11	Enclosures for equipment		-
	Clause 7.1.11 of IEC 60947-1 applies		-
7.1.12	Degree of protection of enclosed equipment		N/A
	Degree of protection .....	IP20	P
	Test for first characteristic		P
	Test for first numeral .....	<input type="checkbox"/> 1: <input checked="" type="checkbox"/> 2: <input type="checkbox"/> 3: <input type="checkbox"/> 4: <input type="checkbox"/> 5: <input type="checkbox"/> 6:	-
	Test for second characteristic		N/A

# TEST REPORT



Report. No.: TCT-TR01-221125-7

Date: 2022-11-25

Page: 13 of 61 pages

	Test for second numeral ..... :	<input type="checkbox"/> 1: <input type="checkbox"/> 2: <input type="checkbox"/> 3: <input type="checkbox"/> 4: <input type="checkbox"/> 5: <input type="checkbox"/> 6: <input type="checkbox"/> 7: <input type="checkbox"/> 8:	-
7.1.14	Class II control circuit devices	No PE terminal provided	P
	These devices shall not be provided with means for protective earthing (see IEC 61140)		-
	For class II control circuit devices insulated by encapsulation, see Annex F	See annex F	-
7.1.15	Requirements for control devices with integrally connected cables		P
		See annex G	-
7.2	Performance requirements		P
	Subclauses 7.2.1.1 and 7.2.2 of IEC 60947-1 apply with the following additions:		P
7.2.1.2	Limits of operation of contactor relays		N/A
	The limits of operation for contactor relays shall be in accordance with IEC 60947-4-1	See clause 8.3.3.2	N/A
7.2.3	Dielectric properties		P
	Subclause 7.2.3 of IEC 60947-1 applies with the following addition	See clause 8.3.3.4	P
	For class II control circuit devices insulated by encapsulation	See Annex F	N/A
7.2.4	Ability to make and break under normal and abnormal load conditions	No switching element	N/A
7.2.4.1	Making and breaking capacities		N/A
	Making and breaking capacities under normal conditions as state in table 4		N/A
	Making and breaking capacities under abnormal conditions as state in table 5		N/A
7.2.4.3	Durability		N/A
	Sub-clause 7.2.4.3 of IEC 60947-1 applies with the following additions:		N/A
	Mechanical durability	See Annex C	N/A
	Electrical durability	See Annex C	N/A
7.2.5	Conditional short-circuit current		N/A
	The switching element shall withstand the stresses resulting from short-circuit current under the conditions specified in 8.3.4		N/A
7.2.7	Additional requirements for control switches suitable for isolation		N/A

## TEST REPORT

Report. No.: TCT-TR01-221125-7

Date: 2022-11-25

Page: 14 of 61 pages



	Control switches suitable for isolation shall be tested according to 8.3.3.4 of IEC 60947-1 with a value of test voltage as specified in Table 14 or IEC 60947-1 corresponding to the rated impulse withstand voltage $U_{imp}$ declared by the manufacturer.		N/A
	Other additional requirements applicable to such control switches are under consideration		N/A
7.2.8	Maximum recovery time		-
	For equipment incorporating electronic circuits the maximum recovery time and the measuring method shall be stated by the manufacturer		-
7.3	Electromagnetic compatibility (EMC)		N/A
	Subclause 7.3 of IEC 60947-1 applies with the following additions:		N/A
	The control circuit device to be tested shall have all the essential design details of the type which it represents and shall be in a clean and new condition.		-
	The EMC tests shall be conducted at rated operational voltage $U_e$ , or if the rated operational voltage is given as a range, then the test shall be conducted at a voltage which represents the worst case condition.		-
	Maintenance or replacement of parts during or after a testing cycle is not permitted.		-
	The products covered by this standard are intended for use in environment A.		-
	Contactors incorporating electronic circuits shall follow the requirements of 8.3.2.2 of IEC 60947-4-1		-

8.3.1	TEST SEQUENCE I (sample No. 1)		P
Test No. 1	- operating limits of contactor relays (8.3.3.2)		N/A
Test No. 2	- temperature rise (Clause 8.3.3.3.)		P
Test No. 3	- dielectric properties (Clause 8.3.3.4)		P
Test No. 4	- mechanical properties of terminals (8.2.4 of IEC 60947-1)		N/A
8.3.3.2	Operating limits of contactor relays		N/A
8.3.3.2.1	Power-operated equipment:		N/A
8.2.1.2.1	Electromagnetic contactors and starters		N/A
	rated control supply voltage $U_s$ (V) .....		N/A
	frequency (Hz) .....		N/A
	declared ambient temperature(>40 °C) for 100% $U_s$		N/A

## TEST REPORT

Report. No.: TCT-TR01-221125-7  
 Date: 2022-11-25  
 Page: 15 of 61 pages



	limits of close satisfactorily at any value between 85% and 110% of rated control supply voltage $U_s$ .. :		N/A
	limits of drop out and open fully are: 75% to 20% for a.c. and 75% to 10% for d.c. .... :		N/A
	ambient temperature(-5 °C) for 100% $U_s$		N/A
	limits of close satisfactorily at any value between 85% and 110% of rated control supply voltage $U_s$ .. :		N/A
	Limits of drop out and open fully are: 75% to 20% for a.c. and 75% to 10% for d.c. .... :		N/A
8.2.1.2.2	Contactors and starters with electronically controlled electromagnet		N/A
	Rated control supply voltage $U_s$ (V) .. :		N/A
	Frequency (Hz) .. :		N/A
	Declared ambient temperature(>40 °C) for 100% $U_s$		N/A
	Limits of close satisfactorily at any value between 85% and 110% of rated control supply voltage $U_s$ .. :		N/A
	Limits of drop out and open fully are: 75% to 20% for a.c. and 75% to 10% for d.c. .... :		N/A
	Ambient temperature(-5 °C) for 100% $U_s$		N/A
	Limits of close satisfactorily at any value between 85% and 110% of rated control supply voltage $U_s$ .. :		N/A
	Limits of drop out and open fully are: 75% to 20% for a.c. and 75% to 10% for d.c. .... :		N/A
8.2.1.2.3	Electro-pneumatic contactors and starters		N/A
	Rated air supply pressure(Bar) .. :		N/A
	Declared ambient temperature(>40 °C) for 100% of the rated air supply pressure(Bar)		N/A
	Limits of close satisfactorily at any value between 85% and 110% of rated air supply pressure(Bar) .. :		N/A
	Limits of drop out and open fully are: 75% to 10% of rated air supply pressure(Bar) .. :		N/A
	Ambient temperature(-5 °C) for 100% of the rated air supply pressure(Bar)		N/A
	Limits of close satisfactorily at any value between 85% and 110% of rated air supply pressure(Bar) .. :		N/A
	Limits of drop out and open fully are: 75% to 10% for the rated air supply pressure(Bar) .. :		N/A
8.3.3.3	Temperature rise		P
	ambient temperature 10-40 °C .. :	23.1°C	P
	test enclosure W x H x D (mm x mm x mm) .. :		N/A
	material of enclosure .. :	PP	P
	NO-contacts, test conditions:		N/A
	- rated operational current $I_e$ (A) .. :		N/A
	- cable cross-section (mm <sup>2</sup> ) .. :		N/A

# TEST REPORT



Report. No.: TCT-TR01-221125-7

Date: 2022-11-25

Page: 16 of 61 pages

	- cable length (m) .....	:		N/A
	- temperature rise of NO terminals (K) .....	:	See table	N/A
	NC-contacts, test conditions:			N/A
	- rated operational current $I_e$ (A) .....	:		N/A
	- cable cross-section (mm <sup>2</sup> ) .....	:		N/A
	- cable length (m) .....	:		N/A
	- temperature rise of NC terminals (K) .....	:	See table	N/A
	Coils and electromagnets, test conditions:			N/A
	- rated control supply voltage $U_s$ (V / Hz) .....	:		N/A
	- Class of insulating material .....	:		N/A
	- temperature rise of coil and electromagnets (K) ...	:	See table	N/A
8.3.3.4	Dielectric properties			N/A
	Test of dielectric properties, impulse withstand voltage ( $U_{imp}$ indicated):			N/A
	- verification by measurement of clearances instead of testing			N/A
	- rated impulse withstand voltage (V) .....	:		N/A
	- test $U_{imp}$ auxiliary circuits (kV) .....	:		N/A
	Test of dielectric properties, dielectric withstand voltage ( $U_{imp}$ not indicated):			P
	- rated insulation voltage (V) .....	:	220 V a.c.	P
	- control and auxiliary circuits, test voltage (V) for 5 sec .....	:	1 500 V d.c.	P
8.2.4	Mechanical and electrical properties of terminals			N/A
8.2.4.2	Mechanical strength of terminals			N/A
	maximum cross-sectional area of conductor (mm <sup>2</sup> ) :			N/A
	diameter of thread (mm) .....	:		N/A
	torque (Nm) .....	:		N/A
	5 times on 2 separate clamping units			N/A
8.2.4.3	Testing for damage to and accidental loosening of conductor (flexion test)			N/A
	conductor of the smallest cross-sectional area (mm <sup>2</sup> ) .....	:		N/A
	number of conductor of the smallest cross section .:			-
	diameter of bushing hole (mm) .....	:		-
	height between the equipment and the platen (mm) .....	:		-
	mass at the conductor(s) (kg) .....	:		-
	135 continuous revolutions: the conductor shall neither slip out of the terminal nor break near the clamping unit			N/A
8.2.4.4	Pull-out test			N/A
	force (N) .....	:		-



## TEST REPORT

Report. No.: TCT-TR01-221125-7

Date: 2022-11-25

Page: 17 of 61 pages



	1 min, the conductor shall neither slip out of the terminal nor break near the clamping unit		N/A
8.2.4.3	Flexion test		N/A
	conductor of the largest cross-sectional area (mm <sup>2</sup> ) :		-
	number of conductor of the largest cross-section ... :		-
	diameter of bushing hole (mm) ..... :		-
	height between the equipment and the platen (mm) ..... :		-
	mass at the conductor(s) (kg) ..... :		-
	135 continuous revolutions: the conductor shall neither slip out of the terminal nor break near the clamping unit		N/A
8.2.4.4	Pull-out test		N/A
	force (N) ..... :		-
	1 min, the conductor shall neither slip out of the terminal nor break near the clamping unit		N/A
8.2.4.3	Flexion test		N/A
	conductor of the largest and smallest cross-sectional area (mm <sup>2</sup> ) ..... :		-
	number of conductor of the smallest cross sectional, number of conductor of the largest cross sectional . :		-
	diameter of bushing hole (mm) ..... :		-
	height between the equipment and the platen (mm) ..... :		-
	mass at the conductor(s) (kg) ..... :		-
	135 continuous revolutions: the conductor shall neither slip out of the terminal nor break near the clamping unit		N/A
8.2.4.4	Pull-out test		N/A
	force (N) ..... :		-
	1 min, the conductor shall neither slip out of the terminal nor break near the clamping unit		N/A
8.2.4.5	Test for insertability of unprepared round copper conductors having the maximum cross-section		N/A
	The test shall be carried out using the appropriate gauge form A or form B specified in Table 7.		N/A
	The measuring section of the gauge shall be able to penetrate freely into the terminal aperture to the full depth of the terminal (see also note to Table 7).		N/A

# TEST REPORT



Report. No.: TCT-TR01-221125-7

Date: 2022-11-25

Page: 18 of 61 pages

	Alternatively, the test can be carried out by inserting the largest conductor of type and rated cross-section among those recommended by the manufacturer, the diameter of which corresponds to the theoretical diameter according to Table 7a, after the insulation has been removed and the end has been reshaped. The stripped end of the conductor shall be able to enter completely within the clamping unit aperture, without use of undue force.		N/A
8.2.4.7	Electrical performance of screwless-type clamping units		N/A
	If terminals are used which are qualified according to IEC 60999-1 and the operating conditions of the terminals in the device are according to the operating conditions specified by the manufacturer of the terminals, then the test does not need to be performed.		N/A
	Sub clause 8.2.4.7 of IEC 60947-1 applies with the following changes:		N/A
	<ul style="list-style-type: none"> <li>- The test shall be done on the connecting device equipped with the clamping units;</li> <li>- The number of specimens shall be at least 8;</li> <li>- The test shall be done as a single 8 test:                             <ul style="list-style-type: none"> <li>• Eight clamping units shall be tested to the declared voltage drop;</li> <li>• If the number of failed clamping units does not exceed two, the test is considered passed.</li> </ul> </li> </ul>		N/A
	test current (A) ..... :		N/A
	voltage drop < 15 mV. (V)..... :		N/A
8.2.4.8	Ageing test for screwless-type clamping units		N/A
	If terminals are used which are qualified according to IEC 60999-1 and the operating conditions of the terminals in the device are according to the operating conditions specified by the manufacturer of the terminals, then the test does not need to be performed.		N/A
	Subclause 8.2.4.8 of IEC 60947-1 applies with the following changes:		N/A
	The test shall be done on the connecting device equipped with the clamping units.		N/A
	test current (A) ..... :		N/A
	maximum temperature for the temperature cycles shall be 40°C. Max. temperature (°C ) ..... :		N/A
	voltage drop ≤ 22,5 mV or 1,5 times the value measured after the 24th cycle. (V) ..... :		N/A
8.3.1	TEST SEQUENCE II (sample No. 2)		N/A
Test No. 1	- Making and breaking capacities of switching elements under normal conditions (8.3.3.5.3)		N/A
Test No. 2	- Dielectric verification (8.3.3.5.6.b)		N/A

# TEST REPORT



Report. No.: TCT-TR01-221125-7

Date: 2022-11-25

Page: 19 of 61 pages

8.3.3.5.3	Making and breaking capacities of switching elements under normal conditions		N/A
	contact element (figure / form) .....		N/A
	contact polarity.....		N/A
	utilization category (AC / DC).....		N/A
	rated operational voltage $U_e$ (V) .....		N/A
	rated operational current $I_e$ (A) or power (kW) .....		N/A
No.1	- test voltage $U/U_e = 1,1$ (V) .....	L1: L2: L3:	N/A
	- power factor/time constant .....	L1: L2: L3:	N/A
	- make operations: test current $I/I_e$ (A) .....	L1: L2: L3:	N/A
	- break operations: test current $I/I_e$ (A) .....	L1: L2: L3:	N/A
	- a.c. test: Inductor shunted by a resistor taking 3% of the total power consumed - d.c. test: test current increase from zero to steady-state value within limits of figure 9		N/A
	- on-time (ms) .....		N/A
	- operating cycles per minute .....		N/A
	- number of operating cycles .....		N/A
	- test voltage $U/U_e = 1,0$ (V) .....	L1: L2: L3:	N/A
	- power factor/time constant .....	L1: L2: L3:	N/A
	- make operations: test current $I/I_e$ (A) .....	L1: L2: L3:	N/A
	- break operations: test current $I/I_e$ (A) .....	L1: L2: L3:	N/A
No. 2	- on-time (ms) .....		N/A
	- operating cycles per minute .....	Rapidly	N/A
	- number of operating cycles .....	10	N/A

# TEST REPORT



Report. No.: TCT-TR01-221125-7

Date: 2022-11-25

Page: 20 of 61 pages

No. 3	- on-time (ms) .....	:		N/A
	- operating cycles per minute .....	:	60	N/A
	- number of operating cycles .....	:	990	N/A
No. 4	- on-time (ms) .....	:		N/A
	- operating cycles per minute .....	:		N/A
	- number of operating cycles .....	:	5000	N/A
Behaviour and condition during and after the test:				N/A
	- no electrical or mechanical failures			N/A
	- no contact welding or prolonged arcing			N/A
	- no blowing of the fusible element in the earth circuit			N/A
8.3.3.5.6.b	Dielectric verification:			N/A
	dielectric test voltage (V) 2 xUe with a min.of 1000V:			N/A

8.3.1	TEST SEQUENCE III (sample No. 3)			N/A
Test No. 1	- Making and breaking capacities of switching elements under abnormal conditions (8.3.3.5.4)			N/A
Test No. 2	- Dielectric verification (8.3.3.5.6.b)			N/A
8.3.3.5.4	Making and breaking capacities of switching elements under abnormal conditions:			N/A
	contact element (figure / form) .....	:		N/A
	contact polarity.....	:		N/A
	utilization category (AC / DC).....	:		-
	rated operational voltage Ue (V) .....	:		-
	rated operational current Ie (A) or power (kW) .....	:		-
	Conditions, make/break operations:			N/A
	- test voltage U/Ue = 1,1 (V) .....	:	L1: L2: L3:	-
	- power factor/time constant .....	:	L1: L2: L3:	-
	- make operations: test current I/Ie (A) .....	:	L1: L2: L3:	-
	- break operations: test current I/Ie (A) .....	:	L1: L2: L3:	-

# TEST REPORT



Report. No.: TCT-TR01-221125-7

Date: 2022-11-25

Page: 21 of 61 pages

	- a.c. test: Inductor shunted by a resistor taking 3% of the total power consumed - d.c. test: test current increase from zero to steady-state value within limits of figure 9		N/A
	- on-time (ms) .....		-
	- operating cycles per minute .....	6	-
	- number of operating cycles .....	10	-
	Behaviour and condition during and after the test:		N/A
	- no electrical or mechanical failures		N/A
	- no contact welding or prolonged arcing		N/A
	- no blowing of the fusible element in the earth circuit		N/A
8.3.3.5.6.b	Dielectric verification:		N/A
	dielectric test voltage (V) 2 xUe with min.of 1000V ..		N/A

8.3.1	TEST SEQUENCE IV (sample No. 4)		N/A
Test No. 1	- Performance under conditional short-circuit current ( 8.3.4)		N/A
Test No. 2	- Dielectric verification (8.3.3.5.6.b)		N/A
8.3.4	Performance under conditional short-circuit current		N/A
	contact element (figure / form) .....		N/A
	contact polarity.....		N/A
	type of SCPD .....		-
	ratings of SCPD (A / V) .....		-
	prospective current (kA) .....		-
	test voltage (V) U/Ue = 1,1 (V) .....		-
	r.m.s. test current obtained (kA) .....		-
	power factor (max. 0,7) .....		N/A
	first CO operation by closing the separate making switch: test Ip / I <sup>2</sup> dt (kA / kA <sup>2</sup> s) .....		-
	time interval between test (min. 3 min) .....		-
	second CO operation by closing the separate making switch: test Ip / I <sup>2</sup> dt (kA / kA <sup>2</sup> s) .....		-
	time interval between test (min. 3 min) .....		-
	third making operation to closed switching elements: test Ip / I <sup>2</sup> dt (kA / kA <sup>2</sup> s) .....		-
	Behaviour of the equipment during the test:		N/A
	switching elements open by the normal actuating system		N/A
8.3.3.5.6.b	Dielectric verification:		N/A

## TEST REPORT

Report. No.: TCT-TR01-221125-7

Date: 2022-11-25

Page: 22 of 61 pages



	dielectric test voltage (V) 2 xUe with min.of 1000V.. :		N/A
8.3.1	TEST SEQUENCE V (sample No. 5)		P
Test No. 1	- Degree of protection of enclosed control circuit-devices (Annex C of IEC 60947-1)		N/A
Test No. 2	- Verification of actuation force or moment (8.2.5)		N/A
Annex C	Degree of protection of enclosed control circuit-devices		N/A
	The enclosed control circuit devices shall comply with the requirements of Annex C of IEC60947-1		N/A
8.2.5	Verification of actuation force or moment		N/A
	When required in 7.1.5.3, the minimum actuating force or moment shall be tested during sequence V of 8.3.1. The performance shall be as stated in 7.1.5.3		N/A
7.1.5.3	Actuating force (or moment)		N/A
	The force (or moment) required to operate the actuator shall be compatible with the intended application, taking into account the size of the actuator, the type of enclosure or panel, the environment of the installation and the use for which it is intended		N/A
	The minimum starting force (or moment) shall be sufficiently large to prevent inadvertent operation; e.g. push-buttons and rotary switches to be used with enclosures complying with degrees of protection IPX5 or IPX6 shall not become actuated when hit by the jet of water applied during the test of the enclosed equipment.		N/A
	Minimum force (N)		-
	Minimum moment (Nm)		-

8.3.1.	TEST SEQUENCE VI (sample No. 6)		P
Test No. 1	- Measurement of clearances and creepage distances (7.1.4 of IEC 60947-1)		P
Test No. 2	- Verification of limitation of rotation of a rotary switch (8.2.6)		N/A
7.1.4	Measurement of clearances and creepage distances		P
	Clearances and creepage distances	See clause 7.1.4	P
8.2.6	Verification of limitation of rotation of a rotary switch		N/A
	When this test is required in 7.1.4.5, it shall be tested during sequence VI of 8.3.1 The test sample shall be mounted according to the manufacturer's instructions		N/A

## TEST REPORT

Report. No.: TCT-TR01-221125-7

Date: 2022-11-25

Page: 23 of 61 pages



7.1.4.5	Limitation of rotation (of a rotary switch)		N/A
	When actuators with limited or unidirectional movement are used, they shall be fitted with robust means of limitation, capable of withstanding five times the actual maximum actuating moment		N/A
8.2.6	The operating moment shall be measured five times and the maximum value recorded (Nm) ..... :		N/A
	The maximum moment value, multiplied by five, shall be applied to the actuator by forcing it against the means of limitation. The moment shall be applied for 10 s (Nm)..... :		N/A
	Means of limitation has not moved, become loose or prevented the actuator's normal operation		N/A

8.4	TEST FOR EMC		P
8.4.1.	General		N/A
	Control circuit devices having only passive components are not required to be tested.		N/A
	Subclauses 8.3.2.1 of IEC 60947-1 and 8.3.2.4 of IEC 60947-1 apply with the following additions:		N/A
	Control circuit devices intended to be mounted in a hole of a panel shall be mounted in a hole which is located in the centre of a grounded square metal plate.		N/A
	Control circuit devices intended to be mounted on surfaces or on standard rails shall be mounted directly on the grounded square metal plate or on the standard rail which is fixed on the grounded square metal plate.		N/A
	Control circuit devices intended to be mounted in associated metal enclosures shall be mounted in the grounded metal enclosure with the smallest dimension available or on the grounded square metal plate, whichever configuration yields the worst results.		N/A
	The dimension of the square metal plate shall be (300 ± 50) mm and the thickness 1,5 <sub>0</sub> <sup>+0,5</sup> mm.		N/A
	If not required otherwise by horizontal standard the connecting leads shall be 2 <sub>0</sub> <sup>+0,1</sup> m. If the length of the connecting leads is other than 2 m. Cable length (m).....:		N/A
	For control circuit devices not having integral cables, the type of cable or wire used shall be specified by the manufacturer: Type of cable.....:		N/A
	The test sample shall be in the ON-status or in the OFF-status, whichever is the worse. Tested state :	ON / OFF	N/A
	Where a range of control circuit devices are made according to the same principle and design, and using the same type of components, tests may be performed on representative samples.		N/A

# TEST REPORT



Report. No.: TCT-TR01-221125-7

Date: 2022-11-25

Page: 24 of 61 pages

8.4.2	Immunity		P
8.4.2.1	Electrostatic discharges.		P
	The test shall be performed according to IEC 61000-4-2 and 7.3.2.4, and shall be repeated 10 times at each measuring point, with a minimum time interval of 1 s between pulses.	See .....	-
8.4.2.2	Radiated radio-frequency electromagnetic fields		P
	The test shall be performed according to IEC 61000-4-3 and 7.3.2.5.	See .....	-
8.4.2.3	Electrical fast transients/bursts		P
	The test shall be performed according to IEC 61000-4-4 and 7.3.2.6, with all the connecting leads placed in the capacitive coupling clamp.	See .....	-
8.4.2.4	Surges		N/A
	The test shall be conducted using the methods of IEC 61000-4-5. Capacitive coupling shall be preferred. Surges shall be supplied between:	See .....	N/A
	a) between terminals intended to be connected to the power supply;		N/A
	b) between each output terminal and each terminal intended to be connected to the power supply		N/A
	The test voltage values are those of Table 8 but shall not exceed the corresponding $U_{imp}$ value(s) given by the manufacturer following 7.2.3 of IEC 60947-1. Test voltages (V).....:		N/A
	The repetition rate shall be one surge per minute, with the number of pulses being five positive and five negative.		N/A
8.4.2.5	Conducted disturbances induced by radio-frequency fields		N/A
	The test shall be performed according to IEC 61000-4-6 and 7.3.2.8.	See .....	N/A
8.4.2.6	Power-frequency magnetic fields		N/A
	The test shall be performed according to IEC 61000-4-8 and 7.3.2.9.	See .....	N/A
8.4.2.7	Voltage dips and interruptions		N/A
	The test shall be performed according to IEC 61000-4-11 and 7.3.2.10.	See .....	N/A
8.4.3	Emission		P
	The test shall be performed according to CISPR 11, group 1, class A, and 7.3.3.	See .....	-



# TEST REPORT

Report. No.: TCT-TR01-221125-7

Date: 2022-11-25

Page: 25 of 61 pages



Annex C of IEC 60947-1	DEGREE OF PROTECTION OF ENCLOSED CONTROL CIRCUIT-DEVICES	N/A
C.1	Scope	N/A
	This annex applies to degrees of protection of enclosed switchgear and control gear at rated voltages not exceeding 1000 V a.c. or 1500 V d.c. hereafter referred as "equipment"	N/A
C.2	Object	N/A
	Clause 2 of IEC 60529 applies with additional requirements of this annex	N/A
C.3	Definitions	N/A
	Clause 3 of IEC 60529 applies except that "Enclosure" is replaced by the following:	N/A
	"A part providing a specified degree of protection of equipment against certain external influences and a specified degree of protection against approach to or contact with live parts and moving parts"	N/A
C.4	Designation	N/A
	Clause 4 of IEC 60529 applies except for letters H, M and S	N/A
C.5	Degrees of protection against access to hazardous parts and against ingress of solid foreign objects indicated by the first characteristic numeral	N/A
	Clause 5 of IEC 60529 applies	N/A
C.6	Degrees of protection against ingress of water indicated by the second characteristic numeral	N/A
	Clause 6 of IEC 60529 applies	N/A
C.7	Degrees of protection against access to hazardous parts indicated by the additional letter	N/A
	Clause 7 of IEC 60529 applies	N/A
C.8	Supplementary letters	N/A
	Clause 8 of IEC 60529 applies	N/A
C.9	Examples of designations with IP Code	N/A
	Clause 9 of IEC 60529 applies	N/A
C.10	Marking	N/A
	Clause 10 of IEC 60529 applies with the following addition:	N/A
	If the IP Code is designated for one mounting position only, it shall be indicated by the symbol 0623 of ISO 7000 placed next to the IP Code specifying this position of the equipment, e.g. vertical	N/A
C.11	General requirements for the tests	N/A
C.11.1	Clause 11.1 of IEC 60529 applies	N/A

## TEST REPORT

Report. No.: TCT-TR01-221125-7

Date: 2022-11-25

Page: 26 of 61 pages



C.11.2	Clause 11.2 of IEC 60529 applies with the following additions:		N/A
	All tests are made in the unenergized state		N/A
	Certain devices(e.g. exposed faces of push-buttons) can be verified by inspection		N/A
	The temperature of the test sample shall not deviate from the actual temperature by more than 5 K		N/A
	Where equipment is mounted in an empty enclosure which already has an IP code the following requirements apply:		N/A
	a) For IP1X to IP4X and additional letters A to D This shall be verified by inspection and compliance with the enclosure manufacturer's instructions		N/A
	b) For IP6X dust test This shall be verified by inspection and compliance with the enclosure manufacturer's instructions		N/A
	c) For IP5X dust test and IP1X to IP8X water tests testing of the enclosed equipment is only required where the ingress of dust or water may impair the operation of the equipment		N/A
C.11.3	Sub clause 11.3 of IEC 60529 applies with the following addition:		N/A
	Drain and ventilating holes are treated as normal openings		N/A
C.11.4	Clause 11.4 of IEC 60529 applies		N/A
C11.5	Where an empty enclosure is used as a component of an enclosed equipment, Clause 11.5 of IEC 60529 applies		N/A
C.12	Degrees of protection against access to hazardous parts indicated by the first characteristic numeral		N/A
	Clause 12 of IEC 60529 applies except for 12.3.2		N/A
C.13	Degrees of protection against ingress of solid foreign objects indicated by the first characteristic numeral		N/A
	Clause 13 of IEC 60529 applies except for		N/A
C.13.4	Dust test for first characteristic numerals 5 and 6		N/A
	Enclosed equipment having a degree of protection IP5X shall be tested according to category 2 of 13.4 of IEC 60 529		N/A
	Enclosed equipment having a degree of protection IP6X shall be tested according to category 1 of 13.4 of IEC 60 529		N/A
C.13.5.2	Acceptance conditions for first characteristic numeral 5		N/A
	The following text to be added:		N/A

# TEST REPORT



Report. No.: TCT-TR01-221125-7

Date: 2022-11-25

Page: 27 of 61 pages

	Where dust deposits could raise as to the correct functioning and safety of the equipment, a preconditioning and a dielectric test shall be conducted as follows:		N/A
	The preconditioning, after dust test, shall be verified by test Ca: damp heat, steady state, according to IEC 60068-2-3, under the following conditions.		N/A
	The equipment shall be prepared so that the dust deposits are subjected to the test by leaving open the lid and/or removing parts, where possible without the aid of tool		N/A
	Before being placed in the chamber the equipment shall be stored at room temperature at least 4 h before the test		N/A
	The test duration shall be 24 consecutive hours		N/A
	After this period the equipment is to be removed from the chamber within 15 min and submitted to a power-frequency dielectric test for 1 min, the value being 2 U <sub>emax</sub> with a minimum of 1000 V (V)..... :	U <sub>test</sub> (V):	N/A
C.14	Tests for protection against ingress of water indicated by the second characteristic numeral		N/A
C.14.1	Clause 14.1 of IEC 60529 applies		N/A
C.14.2	Clause 14.2 of IEC 60529 applies		N/A
C.14.3	Clause 14.3 of IEC 60529 applies with following addition:		N/A
	The equipment's then submitted to a power-frequency dielectric test for 1 min, the value being 2 U <sub>emax</sub> with a minimum of 1000 V (V) .....	U <sub>test</sub> (V):	N/A
C.15	Tests for protection against access to hazardous parts indicated by additional letter		N/A
	Clause 15.1 of IEC 60529 applies		N/A
C.16	Summary of responsibilities of relevant technical committees		N/A

<b>Annex C</b>	<b>SPECIAL TESTS - DURABILITY TESTS</b>		N/A
C.1	General		N/A
C.1.1	Durability declaration		N/A
	The special durability tests described in this annex are conducted at the discretion of the manufacturer		N/A
	Declared number of operating cycles by the manufacturer:		N/A
	- mechanical .....		N/A
	- electrical.....		N/A
C.1.2	Test procedures		N/A
	As stated in 8.3.2.1 and at a rate equal or higher than that declared by the manufacturer		N/A

## TEST REPORT



Report. No.: TCT-TR01-221125-7

Date: 2022-11-25

Page: 28 of 61 pages

	The moving parts of the device shall reach their maximum operating positions in both directions, as recommended by the manufacturer		N/A
C.1.2.2	Single 8 test		N/A
	Eight control circuit devices shall be tested to the declared number of operating cycles..... :		N/A
	If the number of failed devices does not exceed two, the test is considered passed		N/A
C.1.2.3	Double 3 test		N/A
	Three control circuit devices shall be tested to the declared number of operating cycles..... :		N/A
	The test is considered passed if there is no failure, and failed if there is more than one failure.		N/A
	Should there be only one failure, then three additional control devices are tested to the declared number of operating cycles and providing there is no additional failure, the test is considered passed.		N/A
C.1.3	Failure criteria		N/A
	During the tests described in C.2.2 and C.3.2, there shall be no electrical and/or mechanical failures		N/A
	Following the tests, the switching element shall pass the dielectric test of 8.3.3.4 with a rated test voltage equal to 2 U <sub>e</sub> with a minimum of 1000 V (V) ..... :	U <sub>test</sub> (V):	N/A
C.2	Mechanical durability		N/A
C.2.1	General		N/A
	The mechanical durability of a control circuit device is defined as the number of no-load operating cycles which will be attained or exceeding by 90 % of all devices tested without repair or replacement of any part.		N/A
C.2.2	Test procedures		N/A
	Tests are carried out according to C.1.2.		N/A
	During the test, periodically the contacts shall be checked at any voltage and current, selected by the manufacturer, and there shall be no failure	(see C.1.3)	N/A
C.3	Electrical durability		N/A
C.3.1	General		N/A
	Electrical durability of a control device is defined as the number of on-load operating cycles which will be attained or exceeded by 90% of all devices tested, without repair or replacement of any part		N/A
C.3.2	Test procedures		N/A
C.3.2.1	General		N/A

## TEST REPORT

Report. No.: TCT-TR01-221125-7

Date: 2022-11-25

Page: 29 of 61 pages



	Electrical durability tests are carried out by operating the device under the conditions defined in table C.1, in accordance with C.3.2.2 for a.c. or with C.3.2.3. for d.c.		N/A
	Each mechanical operation cycle shall include an interruption of the test current		N/A
	The ON-duration of the current shall not more 50% and not-less than 10% of an operating cycle (ms) ... :	ON-duration (ms):	N/A
	If the test circuit shown in figure C.1 is used, the ON-duration of current at 10 times $I_e$ shall not cause overheating		N/A
	Alternatively these test may be performed on the actual load for which the control switch is intended		N/A
C.3.2.2	AC tests		N/A
	Used circuit ..... :	<input type="checkbox"/> Figure C.1 <input type="checkbox"/> Figure C.2	N/A
	The circuit to be used as shown in fig C.1:		N/A
	- Making circuit consisting air-cored inductor, in series with resistor, power factor of 0,7 ..... :	U test (V): I test (A): Pf:	N/A
	- Breaking circuit consisting air-cored inductor, in series with resistor, parallel damping resistor in which flows 3 % of breaking current, power factor of 0,4 ..... :	U test (V): I test (A): Pf: R (Ohm):	N/A
	If the contact element has a bounce time less than 3 ms, the test may be made with the simplified circuit shown in Figure C.2 ..... :	Bounce time (ms):	N/A
C.3.2.3	DC Tests		N/A
	Used inductor..... :	<input type="checkbox"/> air-cored <input type="checkbox"/> iron-cored	N/A
	The circuit to be used as shown in fig C.1:		N/A
	- circuit consisting air-cored inductor, in series with resistor, parallel damping resistor across the complete circuit in which flows 1 % of test current power factor of $T_{0,95}$ or ..... :	U test (V): I test (A): R (Ohm): $T_{0,95}$ (ms):	N/A
	-circuit consisting iron-cored inductor, in series with resistor, power factor of $T_{0,95}$ $T_{0,95} = 6 \times P$ for $P < 50$ W $T_{0,95} = 300$ ms for $P = 50$ W ..... :	U test (V): I test (A): Pf: R (Ohm):	N/A
<b>Annex E</b>	<b>ITEMS SUBJECT TO AGREE BETWEEN MANUFACTURER AND USER</b>		N/A
	Annex J of IEC 60947-1 applies, as far as covered by clauses and of this standard, with the following additions		N/A

## TEST REPORT

Report. No.: TCT-TR01-221125-7

Date: 2022-11-25

Page: 30 of 61 pages



5.2.5	Relationship between the positions of the actuator of rotary switches and the associated contact element positions in the operating diagram (indication by the manufacturer)		N/A
5.2.6	Characteristics of the delay of time contact elements with adjustable delay of contactors relays (indication by manufacturer)		N/A
6.1.1 (Annex K)	Choice of connecting conductors for position switches with direct opening action		N/A
8.3.1	Test sequences made on one sample only (at manufacturer's request)		N/A
8.3.4.3	Conditional short-circuit current test:		N/A
	- adjustment of the test current if the prospective current is different from 1000 A (to be specified by the manufacturer)		N/A
	- power factor of the test circuit less than 0,5 (with manufacturer's consent)		N/A

<b>Annex F</b>	<b>CLASS II CONTROL CIRCUIT DEVICES INSULATED BY ENCAPSULATION REQUIREMENTS AND TESTS</b>		N/A
F.1	General		N/A
	This annex specifies constructional requirements and tests for class II control circuit devices or parts of devices in which insulation of class II according to IEC 61140 is achieved by encapsulation		N/A
	All non-encapsulated parts shall have clearances and creepage distances two times those specified in 7.1.3		N/A
F.5	Marking		N/A
	Control devices according to this annex shall be marked with the following symbol		N/A
F.7	Instructional and functional requirements		N/A
F.7.1	Choice of compound		N/A
	The compound shall be chosen so that the encapsulated control devices comply with the tests defined in F.8.		N/A
F.7.2	Adhesion of the compound		N/A
	The adhesion of the compound shall be sufficient to prevent the ingress of moisture between the compound and all encapsulated parts and to prevent movement of the encapsulated portion of cable if any.		N/A
	Compliance shall be verified by tests of F.8.2.5 and F.8.1.2.2.		N/A
F.7.3	Dielectric properties		N/A
	Sub-clause 7.2.3 applies with the following changes:		N/A

# TEST REPORT



Report. No.: TCT-TR01-221125-7

Date: 2022-11-25

Page: 31 of 61 pages

	For the verification of the impulse withstand voltage, the test voltage $U_{imp}$ shall be the next higher category of the maximum rated operational voltage in the first column of Table H.1 of IEC 60947-1 for stated overvoltage category .....	$U_{imp}$ (kV):	N/A
	For verification of the power frequency withstand voltage, the test voltage shall be the sum of the voltage stated in Table 12A of IEC 60947-1 plus 1000 V .....	$U_{test}$ (V):	N/A
F.8	Tests		N/A
F.8.1	Kind of tests		N/A
F.8.1.1	General		N/A
	Sub clause 8.1.1 of IEC 60947-1 applies		N/A
F.8.1.2	Type test		N/A
	The following sequence of 6 tests shall be applied to each of 3 samples in the specified order		N/A
F.8.1.2.1	Dielectric tests in new conditions		N/A
	Sub clause 8.3.3.4 of IEC 60947-1 applies with the exception that the values of voltages shall be applied between the stripped joined ends of the cable or the shorted terminals and any point of the surface (or metallic foil on the surface) of the encapsulated device (see fig F.1)		N/A
	No breakdown of the insulation shall occur		N/A
F.1.2.2	Cable tests (if applicable)		N/A
	Control circuit devices provided with integrally connected cables shall comply with the requirements of Annex G		N/A
F.8.1.2.3	Rapid change of temperature test		N/A
	Test Na shall be performed in accordance with IEC 60068-2-14 with the following values:		N/A
	$T_a$ and $T_b$ are the minimum and the maximum temperatures stated in f.2.3 .....	$T_a$ (°C): $T_b$ (°C):	N/A
	Transition time $t_2$ .....	$t_2 = 2$ to 3 min	N/A
	Number of cycles .....	5	N/A
	Exposure time $t_1$ .....	$t_1 = 3$ h	N/A
	After the test no visible damage shall be observed		N/A
F.8.1.2.4	Impact test		N/A
	The test is performed as follow:	See Figure F.2	N/A
	Three impacts of 0,5 Joule shall applied near the centre of the largest surface or the longest axis (for cylindrical shape) of the encapsulated device		N/A
	The impacts are provided by dropping a steel ball of 0,25 kg from a height of 0,20 m		N/A

## TEST REPORT

Report. No.: TCT-TR01-221125-7

Date: 2022-11-25

Page: 32 of 61 pages



	The support is considered sufficiently rigid if its displacement under the impact energy is lower than 0,1 mm		N/A
	After the test no visible damage shall be observed		N/A
F.8.1.2.5	Damp heat, cyclic		N/A
	Test Db shall be performed in accordance with IEC 60068-2-30 with the following values:		N/A
	Upper temperature .....	55 °C	N/A
	Number of cycles .....	6	N/A
	Variant.....	<input type="checkbox"/> 1 <input type="checkbox"/> 2	N/A
	After the test no visible damage shall be observed		N/A
F.8.1.2.6	Dielectric test after stresses		N/A
	Test of dielectric properties, dielectric withstand voltage (Uimp not indicated):		N/A
	rated insulation voltage (V) test voltage (V) for 5 sec .....	Utest (V):	N/A
	Leakage current measurements at 1,1 Ui shall not exceed 2 mA.....	Leakage current (mA):	N/A

<b>Annex G</b>	<b>ADDITIONAL REQUIREMENTS FOR CONTROL CIRCUIT DEVICES WITH INTEGRALLY CONNECTED CABLES</b>		P
G.1	General		P
	This annex gives additional requirements applying to control circuit devices with integrally connected cables for electrical connection to other equipment and / or to the power source.		P
	The cable integrally connected to such control devices is not considered replaceable by the user.		P
	This annex states the constructional and performance requirements for the cable, the cable anchorage and the cable entrance seal		P
G.7	Constructional and performance requirements		P
G.7.1	Constructional requirements		P
G.7.1.1	Cable material		P
	The control device shall be provided with flexible cable of appropriate voltage, current and temperature rating and environmental condition		P
G.7.1.2	Cable anchorage		P
	The cable anchorage shall be such that a force being applied to the cable is not transmitted to electrical connections integral to the device		P
	Movement of the cable into or out of the control circuit device shall not cause damage to the connection or internal parts of the device		P



## TEST REPORT



Report. No.: TCT-TR01-221125-7

Date: 2022-11-25

Page: 33 of 61 pages

G.7.1.3	Cable entrance sealing means		N/A
	A sealing means shall provided at the cable entrance to the control circuit device suitable for the degree of protection or internal parts of the device		N/A
G.7.2	Performance requirements		P
	The cable and the cable entrance sealing means shall be capable of withstanding the tests given in G.8		P
G.8	Tests		P
	The purpose of these tests is to ensure integrity of the cable anchorage during handling and installation. Once installed, the control circuit device and cable should be fixed relative to each other		P
G.8.2	Type test		P
	The following sequence of four test shall be performed on a representative sample in the specified order		P
G.8.2.2	Pull-out test		P
	The cable shall be subjected to a steady pull along the axis of the cable entry, applied to the insulating jacket of the cable for a duration of 1 min		P
	Sub clause 8.2.4.4 of IEC 60947-1 applies.		-
	In cases when cables consist of more than one conductor the pulling force is determined by multiplying the pulling force for a single conductor by the number of conductors in the cable. The maximum pulling force shall not exceed 160 N..... :	Diameter cable (mm): Pull force (N):	-
G.8.2.3	Torque test		P
	The cable shall be subjected to a torque of 0,1 Nm or limited to the value giving an angle of torque of 360°..... :	Torque (Nm):	P
	The torque shall be applied clockwise and then counter-clockwise for 1 min, to the cable at a distance of 100 mm from the control circuit device entrance		P
G.8.2.4	Push test		P
	The push force shall be applied along the axis of the cable as close as possible to the cable entrance		P
	The force is increased to 20 N. The force shall be applied for 1 min for each time and with 1 min pause between applications		P
	After the tests, no visible damage of the cable entrance sealing means and no displacement of the cable shall be observed		P
G.8.2.5	Bend test		P
	The cable shall be loaded and bent in the following manner:		P

# TEST REPORT

Report. No.: TCT-TR01-221125-7

Date: 2022-11-25

Page: 34 of 61 pages



	a) suspend a 3 kg mass by attaching it to the cable, 1 m from the cable entrance and with the axis of the cable entrance vertical		P
	b) tilt the control circuit device 90° to cause a 90° bend in the cable, maintaining that position for 1 min		P
	c) tilt the control device 90° in the opposite direction relative to vertical so as to cause an opposite 90° bend in the cable, maintaining the position for a duration of 1 min.		P
G.8.3	Results to be obtained		P
	There shall be no damage to the cable, cable sealing means, cable entrance or the electrical connecting means of the control circuit device.		P
	This will be verified by visual examination and verification of compliance with the stated IP designation	See 7.1.11	P

<b>Annex H</b>	<b>ADDITIONAL REQUIREMENTS FOR SEMICONDUCTOR SWITCHING ELEMENTS FOR CONTROL CIRCUIT DEVICES</b>		N/A
H.3	Classification		N/A
H.3.1	Semiconductor switching elements may be classified as follows:		N/A
	1) Utilization categories (see 4.4. and H.4.2)		N/A
	2) Electrical ratings based on utilization categories (see annex A)		N/A
H.5	Product information		N/A
	The following information shall be given by the manufacturer:		N/A
	Clause 5.1 applies with the following additions:		N/A
	Basic rated values and utilization		N/A
	a) Voltage drop (H.7.1.1) .....	U <sub>d</sub> (mV):	N/A
	b) Minimum operational current .....	I <sub>m</sub> (A):	N/A
	c) Off-state current.....	I <sub>r</sub> (A):	N/A
	d) Making and breaking capacities .....	AC ___ / DC ___	N/A
	e) Conditional short-circuit current.....	Normal 1000 A at U <sub>e</sub>	N/A
	f) Electromagnetic compatibility, EMC.....	<input type="checkbox"/> environment A <input type="checkbox"/> environment B	N/A
H.8	Tests		N/A
H.8.1	Type test		N/A
	Subclause 8.1.2 applies with the following additions:		N/A
H.8.2	Voltage drop (U <sub>d</sub> )		N/A
	The voltage drop is measured across the active output of the switching element in the ON state and carrying the current range of I <sub>m</sub> and I <sub>e</sub> at an ambient temperature of 23°C ± 5 °C and at rated frequency.		N/A

## TEST REPORT

Report. No.: TCT-TR01-221125-7

Date: 2022-11-25

Page: 35 of 61 pages



	The measurement is performed with the circuit in figure H.2, with the switch S closed. The loads shall be resistive and R <sub>2</sub> is adjusted to obtain the test current with the supply voltage .....	U <sub>e</sub> (V): I <sub>m</sub> (A): I <sub>e</sub> (A):	N/A
	Voltage drop at I <sub>m</sub> .....	U <sub>d</sub> (mV):	N/A
	Voltage drop at I <sub>e</sub> .....	U <sub>d</sub> (mV):	N/A
	The measured voltage drop exceed not the specified value in H.7.1.1		N/A
H.8.3	Minimum operational current (I <sub>m</sub> )		N/A
	The test is performed with the switching element connected to a test circuit shown in fig H.2. With supply voltage (U <sub>e</sub> ), the switch open and the switching element in ON-state conduction, the resistive load R1 is adjusted to obtain the current I <sub>m</sub> :	U <sub>e</sub> (V): I <sub>m</sub> (A):	N/A
	The measured value shall be according to H.7.1.2.. :	Min. stated value: I <sub>m</sub> (A): Measured: I <sub>m</sub> (A):	N/A
H.8.4	OFF-state current (I <sub>r</sub> )		N/A
	With the circuit in Figure H.2, and the S switch closed, the load R2 is adjusted to obtain the rated operational current (I <sub>e</sub> ) when the highest supply voltage (U <sub>e</sub> ) is connected to the circuit. The switching element is then turned off and the OFF-state current is measured .....	U <sub>e</sub> (V): I <sub>e</sub> (A):	N/A
	The measured value shall be according to H.7.1.3.. :	Min. stated value: I <sub>r</sub> (A): Measured: I <sub>r</sub> (A):	N/A
H.8.5	Making and breaking capacities		N/A
	Subclause 8.3.3.5 applies		N/A
8.3.3.5.2	Making and breaking capacities of switching elements under normal conditions		N/A
	contact element (figure / form) .....		N/A
	contact polarity .....		N/A
	utilization category (AC/DC) .....		N/A
	rated operational voltage U <sub>e</sub> (V) .....		N/A
	rated operational current I <sub>e</sub> (A) or power (kW) .....		N/A
Test No.1	- test voltage U/U <sub>e</sub> = 1,1 (V) .....	L1: L2: L3:	N/A
	- power factor/time constant .....	L1: L2: L3:	N/A
	- make operations: test current I/I <sub>e</sub> (A) .....	L1: L2: L3:	N/A

# TEST REPORT



Report. No.: TCT-TR01-221125-7

Date: 2022-11-25

Page: 36 of 61 pages

	- break operations: test current I/Ie (A) .....	L1: L2: L3:	N/A
	- a.c. test: Inductor shunted by a resistor taking 3% of the total power consumed - d.c. test: test current increase from zero to steady-state value within limits of figure 9		N/A
	- on-time (ms) .....		N/A
	- operating cycles per minute .....	6	N/A
	- number of operating cycles .....	50	N/A
	- test voltage U/Ue = 1,0 (V) .....	L1: L2: L3:	N/A
	- power factor/time constant .....	L1: L2: L3:	N/A
	- make operations: test current I/Ie (A) .....	L1: L2: L3:	N/A
	- break operations: test current I/Ie (A) .....	L1: L2: L3:	N/A
Test No. 2	- on-time (ms) .....		N/A
	- operating cycles per minute .....	Rapidly	N/A
	- number of operating cycles .....	10	N/A
Test No. 3	- on-time (ms) .....		N/A
	- operating cycles per minute .....	60	N/A
	- number of operating cycles .....	990	N/A
Test No. 4	- on-time (ms) .....		N/A
	- operating cycles per minute .....		N/A
	- number of operating cycles .....	5000	N/A
	Behaviour and condition during and after the test:		N/A
	- no electrical or mechanical failures		N/A
	- no contact welding or prolonged arcing		N/A
	- no blowing of the fusible element in the earth circuit		N/A
	Dielectric verification:		N/A
	dielectric test voltage (V) 2 xUe with a min.of 1000V:		N/A
8.3.3.5.3	Making and breaking capacities of switching elements under abnormal conditions:		N/A
	contact element (figure / form) .....		N/A
	contact polarity.....		N/A

# TEST REPORT



Report. No.: TCT-TR01-221125-7

Date: 2022-11-25

Page: 37 of 61 pages

	utilization category (AC/DC)..... :		-
	rated operational voltage Ue (V) .....		-
	rated operational current Ie (A) or power (kW) .....		-
	Conditions, make/break operations:		N/A
	- test voltage U/Ue = 1,1 (V) .....	L1: L2: L3:	-
	- power factor/time constant .....	L1: L2: L3:	-
	- make operations: test current I/Ie (A) .....	L1: L2: L3:	-
	- break operations: test current I/Ie (A) .....	L1: L2: L3:	-
	- a.c. test: Inductor shunted by a resistor taking 3% of the total power consumed - d.c. test: test current increase from zero to steady-state value within limits of figure 9		N/A
	- on-time (ms) .....		-
	- operating cycles per minute .....	6	-
	- number of operating cycles .....	10	N/A
	Behaviour and condition during and after the test:		N/A
	- no electrical or mechanical failures		N/A
	- no contact welding or prolonged arcing		N/A
	- no blowing of the fusible element in the earth circuit		N/A
	Dielectric verification:		N/A
	dielectric test voltage (V) 2 xUe with min.of 1000V.. :		N/A
H.8.6	Performance under short-circuit conditions		N/A
8.3.4	Performance under conditional short-circuit current		N/A
	contact element (figure / form) .....		N/A
	contact polarity..... :		N/A
	Maximum cable length	2 m	N/A
	type of SCPD .....		-
	ratings of SCPD (A / V) .....		-
	prospective current (min- 1 kA) (kA) .....		-
	test voltage (V) 1,1 x Ue .....		-
	r.m.s. test current obtained (kA) .....		-
	power factor (0,5- 0,7) / T <sub>0,95</sub> (ms)..... :		N/A

# TEST REPORT



Report. No.: TCT-TR01-221125-7

Date: 2022-11-25

Page: 38 of 61 pages

	first CO operation by closing the separate making switch: test $I_p / I^2dt$ (kA / kA <sup>2</sup> s) .....	L1:	-
	time interval between test (min. 3 min) .....		-
	second CO operation by closing the separate making switch: test $I_p / I^2dt$ (kA / kA <sup>2</sup> s) .....	L1:	-
	time interval between test (min. 3 min) .....		-
	third CO operation by closing the separate making switch: test $I_p / I^2dt$ (kA / kA <sup>2</sup> s) .....	L1:	-
	.....		
8.3.4.4	Condition of the switching element after the test		N/A
	switching elements open by the normal actuating system		N/A
	Dielectric verification:		N/A
	dielectric test voltage (V) 2 xU <sub>e</sub> with min.of 1000V ..		N/A
H.8.7	Verification of electromagnetic compatibility		N/A
H.8.7.1	General		N/A
	Subclause 8.4.1 applies with the following addition:		N/A
	The tests shall be performed: with the switching element in the ON-state with the switching element in the OFF-state		N/A
H.8.7.2	Immunity		N/A
H.8.7.2.4	Surges		N/A
	Subclause 8.4.2.4 applies with the following addition:		N/A
	the switching element is powered during the test		N/A
	Five positive and five negative impulses shall be applied between each two points at intervals of not less than 5 s		N/A
H.8.7.3	Emission		N/A
	The test shall be performed under worst case conditions according to CISPR 11 Group 1, Class A, and 7.3.3.2 of IEC 60947-1		N/A
	These limits are given for switching elements exclusively intended for use in industrial environment A. When they can be used in domestic environment B, the following notice shall be included in the instructions for use	NOTICE This is a Class A product. In a domestic environment this product may cause radio interference in which case the user may be required to take adequate measures	N/A
<b>Annex J</b>	<b>SPECIAL REQUIREMENTS FOR INDICATOR LIGHTS AND INDICATING TOWERS</b>		<b>P</b>
J.3	Classification		P
	Indicator lights may be classified by:		P

# TEST REPORT



Report. No.: TCT-TR01-221125-7

Date: 2022-11-25

Page: 39 of 61 pages

	rated electrical power		P
	colour		P
	Fixing hole diameter		P
	Means of connection		P
	Nature of current and frequency		P
	Type of lamp socket		P
	Nature of light source (for example: filament lamp, LED).		P
J.4	Characteristics		P
J.4.1	Rated operational voltage of an indicator light (V) ... :		P
J.4.2	Rated thermal power of an indicator light (W) ..... :		P
J.4.3	Rated values of the lamp ..... :		P
J.5	Product information		P
	a - manufacturer's name or trademark		P
	b - type designation or serial number		P
	c – the following markings shall appear on the indicator light		P
	1 rated voltage of indicator light		P
	2 rated voltage of the lamp		P
	3 rated power of the lamp or its type designation, or rated current for a LED		P
J.6	Normal service, mounting and transport conditions		P
	There are no supplementary requirements		P
J.7	Constructional and performance requirements		P
	Clause 7 applies with the following additions		P
J.7.1.12	Indicator lights with build-in transformers		N/A
	The transformer shall have separate windings		N/A
	It is assumed that this condition is fulfilled if the indicator light passes the test described in 8.3.3.4.1		N/A
J.7.2.1.6	Limits of operation		N/A
	The limit value of the supply voltage at the terminals of the indicator light shall be 1,1, times the rated operational voltage		N/A
	This requirement is verified only for indicator lights with built-in transformer according the test described in J.8.3.3.3		N/A
J.7.2.5.1	Short-circuit withstandability of build-in transformer		N/A
	The transformer shall be able to withstand the short-circuit of its secondary winding.		N/A
	It is assumed that this condition is fulfilled if the indicator light passes the test described in 8.3.3.3.		N/A

## TEST REPORT



Report. No.: TCT-TR01-221125-7

Date: 2022-11-25

Page: 40 of 61 pages

J.8	Tests		P
J.8.3	Tests for indicator lights and indicator towers		P
	The tests are type tests. No additional test (routine test or special test) is described in this annex		P
	Each of the tests in J 8.3.3.3, -3.4, -4, and j.8.4 shall be made on new apparatus		P
J.8.3.3.3	Temperature-rise test		P
	a) If the indicator light has the same rated thermal power (see J.4.2) regardless of mounting conditions, a single test is made in an insulated enclosure.		P
	b) If the rated thermal power (see J.4.2) is dependent on the mounting conditions, two tests are made: - on a steel plate, and - in an insulated enclosure		N/A
	c) Mounting on a steel plate Five indicator lights fitted with green lenses are fixed in accordance with the following diagram on a steel plate 2 mm thick, painted black		N/A
	The plate is located vertically on a table and the indicator lights are supplied at their rated voltage .... :	U <sub>test</sub> (V):	N/A
	The duration of the test shall be such that a steady-state temperature is reached		N/A
	d) Mounting in an insulating enclosure The test described in item c) is carried out again. With the lights into an enclosure of insulating material, such as Bakelite-coated paper 2 mm thick		P
	The plate is located vertically on a table and the indicator lights are supplied at their rated voltage .... :	U <sub>test</sub> (V):	P
	The duration of the test shall be such that a steady-state temperature is reached		P
	Results obtained on the follow points:		P
	- on the body of the indicator light (K)..... :	measured (K): allowed (K):	P
	- on the terminals..... :	measured (K): allowed (K):	N/A
	- on the accessible part of the lens ..... :	measured (K): allowed (K):	P
	f) For indicating towers, an arrangement of 5 units shall be mounting in vertical position. The shall be loaded maximum power of the lamp at the nominal voltage ..... :	U <sub>test</sub> (V):	P
	The duration of the test shall be such that a steady-state temperature is reached		P



## TEST REPORT

Report. No.: TCT-TR01-221125-7

Date: 2022-11-25

Page: 41 of 61 pages



	- on the accessible part of the centre lens of the tower .....	measured (K): allowed (K):	P
	None of the corresponding temperature rises exceed the limits of 7.2.2 of IEC60947-1		P
J.8.3.3.4	Dielectric tests		P
	Clause 8.3.3.4 applies		P
J.8.3.3.4.3	Indicator lights with build-in transformers		N/A
	Two additional dielectric tests shall be made, the duration of each being 1 min		N/A
	- between the primary and secondary windings of the transformer with the test voltage value specified in 8.3.3.4 .....	Utest (V):	N/A
	- between the secondary windings of the transformer and the frame of the indicator light with a test voltage of 1000 V		N/A
J.8.3.4	Short-circuit test (on built-in transformer, if any)		N/A
	The test are made under the following conditions:		N/A
	- primary voltage: 1,1 x Ue .....	Utest (V):	N/A
	- ambient air temperature: 20 °C ± 5 °C .....	Ambient (°C):	N/A
	- duration: 1 h		N/A
	The transformer shall be short-circuit by a conductor of negligible impedance		N/A
	After the test and after cooling to ambient, temperature, the transformer withstand the dielectric test defined in J.8.3.3.4.3		N/A
J.8.3.3.4.3	Indicator lights with build-in transformers		N/A
	Two additional dielectric tests shall be made, the duration of each being 1 min		N/A
	- between the primary and secondary windings of the transformer with the test voltage value specified in 8.3.3.4 .....	Utest (V):	N/A
	- between the secondary windings of the transformer and the frame of the indicator light with a test voltage of 1000 V		N/A
J.8.4	Shock and vibration		P
J.8.4.1	General		P
	Tests for shock and vibration shall be carried out for indicating towers only. Indicator lights are not considered to be tested.		P
J.8.4.2	Direct mounting		P
J.8.4.2.1	General		P

## TEST REPORT

Report. No.: TCT-TR01-221125-7

Date: 2022-11-25

Page: 42 of 61 pages



	An indicating tower with five signalling units shall be mounted as stated by the manufacturer without extension poles and the upper three units powered at the rated voltage..... :	U <sub>test</sub> (V):	P
	The test shall be performed as follows		P
J.8.4.2.2	Shock		P
	In accordance with IEC 60068-2-27 with the follow conditions		P
	Six shocks applied in each direction along three perpendicular axes (a total of 36 shocks):	- pulse shape: half-sine - peak acceleration: 15 g <sub>n</sub> - duration of pulse: 11 ms	P
J.8.4.2.3	Vibration		P
	In accordance with IEC 60068-2-6 with the following conditions, along three mutually perpendicular axes:	- frequency range: 10 to 55 Hz - amplitude: 0,5 mm - sweep cycle duration: 5 min - duration at resonant frequency or at 55 Hz: 30 min in each of the 3 axes (90 min in total)	P
J.8.4.3	Indirect support mounting		P
	If the product literature includes other allowable mounting conditions (e.g. pole mounting), the manufacturer shall state the severity level for shock and vibration tests at which the requirements of J.8.4.3 are met		P
J.8.4.4	Results to be obtained		P
	After the tests, no visible damage shall be observed and the signalling shall not be impaired		P
J.8.5	Degree of protection for indicating towers		P
	If the manufacturer declares a degree of protection, the test shall be conducted according to Annex C of IEC 60947-1 with all removable parts equipped as in normal service.		P

<b>Annex K</b>	<b>SPECIAL REQUIREMENTS FOR CONTROL SWITCHES WITH DIRECT OPENING ACTION</b>		N/A
K.1	General		N/A
	All control switches with direct opening action shall also comply with the relevant requirements of the standard and, where applicable. To those given in Annexes F, G, H and/or J		N/A
K.3	Classification		N/A
	There are two types of control switches with direct opening action: .....	<input type="checkbox"/> type 1 <input type="checkbox"/> type 2	N/A
K4	Characteristics		N/A
K.4.3.1.2	Rated insulation voltage ( min. 250 V) .....	U <sub>i</sub> (V):	N/A

# TEST REPORT



Report. No.: TCT-TR01-221125-7

Date: 2022-11-25

Page: 43 of 61 pages

K.4.3.2.1	Conventional free air thermal current (min. 2.5 A) .. :	Ith (A):	N/A
K.4.4	Utilization categories for switching elements (AC-15 or DC-13) .. :		N/A
K.5	Product information		N/A
	Clause 5 is applies with the following additions		N/A
K.5.2	Marking		N/A
K.5.2.7	Every contact element with direct action shall be marked on the outside by the symbol	 IEC 60617-S00226 (2001-07)	N/A
K.5.2.8	Electrical separation for change-over contact element		N/A
	Change-over contact elements with four terminal shall be indelibly and legibly marked with the relevant form Zap or Zebu as state in Figure 4.		N/A
K.5.2	Additional product information		N/A
K.5.4.1	Actuator travel and operation force		N/A
	The manufacturer shall state the following		N/A
	a) the minimum direct opening travel (mm)..... :		N/A
	b) the minimum force to achieve direct opening action of all break contacts (N) .. :		N/A
	c) the maximum travel including travel beyond the minimum travel position (mm)..... :		N/A
	d) for limit switches only the maximum speed of actuation .. :		N/A
	e)for limit switches only the maximum frequency of actuation .. :		N/A
	These statements shall appear in the marking or on the circuit diagram or other documents		N/A
K.5.4.2	Short-circuit protection		N/A
	Type of short-circuit protective device shall be stated either as marking on the switch or in the installation instruction		N/A
K.6	Normal service, mounting and transport conditions		N/A
	Clause 6 applies, with the following additions:		N/A
K.6.1.1	Ambient air temperature		N/A
	Sub clause 6.1.1 of IEC 60947-1 applies, except for position switches with direct opening action, for which the upper and lower limits of temperature are respectively +70 °C and +25 °C, and the average temperature, measured over a period of 24 h, does not exceed +35 °C		N/A
K.7	Constructional and performance requirements		N/A
	Clause 7 applies with following additions:		N/A
K.7.1.4.3.1	Robustness of the actuating system		N/A

# TEST REPORT

Report. No.: TCT-TR01-221125-7  
 Date: 2022-11-25  
 Page: 44 of 61 pages



	The actuating system shall pass the test described in K.8.3.7		N/A
K.7.1.4.3.2	Directness of the opening action		N/A
	The control switch with direct opening action shall pass the tests K.8.3.4, K.8.3.5 and K.8.3.7 without any deformation that would reduce the impulse voltage withstand across the contact gap.		N/A
K.7.1.4.5	Automatic opening of cable operated control switches		N/A
	In case of failure of the cable or its anchorage automatic return to open position		N/A
K.7.1.4.6	Conditions for direct opening action		N/A
	Parts of travel that separates the contacts, shall have no resilient member (springs) between the moving contacts and the point of the actuator to which the actuating force is applied		N/A
K.7.1.4.6.1	Contact elements types		N/A
	Control switches with direct opening action may be provided with snap-on or dependent action contact elements		N/A
	Break-contact shall be electrically separated from each other and from the operating make-contact element		N/A
	If C or Za change-over contact elements, only 1 contact element shall be used, and in case of Zebu change-over, both may be used		N/A
K.7.1.5.3	Actuator travel indication		N/A
	In order to facilitate the setting-up of the switch actuator in relation to the external operating means, the switch may include means for indicating the minimum travel		N/A
K8	Tests		N/A
	In addition to clause 8, and Annex, the following applies		N/A
K.8.3.1	Test sequences		N/A
	Clause 8.3.1 applies with the following additions:		N/A
			N/A
	<b>TEST SEQUENCE VII (Sample 7)</b>		N/A
	Mechanical operation of position switches with direct opening action		N/A
K.8.3.5	Test no.1 - Mechanical operation of position switches at limits of temperature		-
K.8.3.6	Test no.2 – Verification of direct opening action		N/A
K.8.3.5	Mechanical operation of position switches at limits of temperature		N/A
	The position switch shall be conditioned at 70°C for 8 hours .....		N/A

## TEST REPORT

Report. No.: TCT-TR01-221125-7  
 Date: 2022-11-25  
 Page: 45 of 61 pages



	After 8 hours the contact shall be loaded with the maximum rated operational current for 10 min (A)... :		N/A
	The contact then be operated 10 times by the application of the force stated by the manufacturer (N) .....		N/A
	The test shall be repeated, the switch shall be conditioned at - 25 °C for 8 hours .....		N/A
	The contact then be operated 10 times by the application of the force stated by the manufacturer (N) .....		N/A
K8.3.6	Verification of direct opening action		N/A
	Impulse voltage test over the open position of the contacts at 2500 V or for position switches for isolation in accordance with table 14 of IEC 60 947-1 or as declared Uimp by the manufacturer (V) .....		N/A
	5 positive and 5 negative impulses are applied .....	Utest (V):	N/A
	TEST SEQUENCE VIII (Sample 8)		N/A
K.8.3.7	Verification of robustness of the actuating system		N/A
	Closed break contact(s) shall be loaded with a force F1 of 10 N .....		N/A
	Stated openings force F2 shall be applied to the actuator through the direct opening travel (N) .....		N/A
	After the test the actuating system and / or contacts shall remain functional .....		N/A
	Impulse voltage test in accordance with K.8.3.6		N/A
	Impulse voltage test over the open position of the contacts at 2500 V or for position switches for isolation in accordance with table 14 of IEC 60 947-1 or as declared Uimp by the manufacturer .....		N/A
	5 positive and 5 negative impulses are applied .....	Utest (V):	N/A
K.8.3.4	Performance under conditional short circuit current		N/A
	Sub clause 8.3.4 applies with the following additions:		N/A
K.8.3.4.2.1	Verification of the conditional short-circuit current		N/A
	The test shall be made as stated in 8.3.4.2, except that the current is made by a direct opening contact element and not by the additional switching device and the test is made on the device by making the current three times by the same contact element in a single phase circuit.		N/A
	For type 2 control switches, the contact element shall be chosen at random		N/A

# TEST REPORT



Report. No.: TCT-TR01-221125-7

Date: 2022-11-25

Page: 46 of 61 pages

	Performance under conditional short-circuit current		N/A
	contact element (figure / form) .....		N/A
	contact polarity.....		N/A
	type of SCPD .....	Fuse gL/gG	-
	ratings of SCPD (A / V) .....		N/A
	prospective current (min- 1 kA) (kA).....		N/A
	test voltage (V) U/Ue = 1,1 (V) .....	L1:	N/A
	r.m.s. test current obtained (kA) .....	L1:	N/A
	power factor (max. 0,7)		N/A
	Sample 4		N/A
	first C operation by closing the switch element Ip / I²dt (kA / kA²s) .....	L1: L1: L1:	N/A
	time interval between test (min. 3 min) .....		N/A
	second C operation by closing the switch element Ip / I²dt (kA / kA²s).....	L1: L1: L1:	N/A
	time interval between test (min. 3 min) .....		N/A
	third C operation by closing the switch element Ip / I²dt (kA / kA²s) .....	L1: L1: L1:	N/A
	Sample 9		N/A
	first C operation by closing the switch element Ip / I²dt (kA / kA²s).....	L1: L1: L1:	N/A
	time interval between test (min. 3 min) .....		N/A
	second C operation by closing the switch element Ip / I²dt (kA / kA²s).....	L1: L1: L1:	N/A
	time interval between test (min. 3 min) .....		N/A
	third C operation by closing the switch element: Ip / I²dt (kA / kA²s).....	L1: L1: L1:	N/A
	Sample 10		N/A
	first C operation by closing the switch element Ip / I²dt (kA / kA²s).....	L1: L1: L1:	N/A
	time interval between test (min. 3 min) .....		N/A

# TEST REPORT

Report. No.: TCT-TR01-221125-7

Date: 2022-11-25

Page: 47 of 61 pages

	second C operation by closing the switch element $I_p / I^2dt$ (kA / kA <sup>2</sup> s)..... :	L1: L1: L1:	N/A
	time interval between test (min. 3 min) .....		N/A
	third C operation by closing the switch element $I_p / I^2dt$ (kA / kA <sup>2</sup> s)..... :	L1: L1: L1:	N/A
K.8.3.4.4.1	Operation ability after the test		N/A
K.8.3.4.4.1	After each test, the opening contact element shall open by the application of the force stated by the manufacturer through the direct opening travel (see items a) and b) of K.5.4.1).		N/A
	Impulse voltage test in accordance with K.8.3.6		N/A
	Impulse voltage test over the open position of the contacts at 2500 V or for position switches for isolation in accordance with table 14 of IEC 60 947-1 or as declared $U_{imp}$ by the manufacturer .....		-
	5 positive and 5 negative impulses are applied .....	$U_{test}$ (V):	N/A

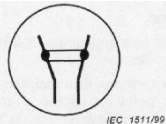
<b>Annex L</b>	<b>SPECIAL REQUIREMENTS FOR MECHANICALLY LINKED CONTACT ELEMENTS</b>		N/A
L.1	General		N/A
	This annex applies to mechanically linked auxiliary contact elements included in control circuit devices where actuating force is provided internally, such as contactor relays		N/A
	Linkage between the auxiliary and main contacts is not covered by this annex		N/A
L.5	Product information		N/A
	Clause 5 applies with the following addition		N/A
L.5.2.7	Mechanically linked contact elements identification and marking		N/A
	Mechanically linked contact elements shall be clearly identified:		N/A
	on the control circuit device itself; or in the manufacturers documentation or both		N/A
	The mechanical linkage shall be identified in circuit diagrams by a double parallel line connecting a filled circle on each of the mechanically linked contact symbols.		N/A
	If the devices containing some or all mechanically linked contacts are marked, the symbol shown shall be used		N/A
L.7	Constructional and performance requirements		N/A

## TEST REPORT

Report. No.: TCT-TR01-221125-7

Date: 2022-11-25

Page: 48 of 61 pages



	Clause 7 applies with the following addition:		N/A
L.7.1.9	Requirements for mechanically linked contact elements		N/A
	While any of the n Make contact element(s) is closed, none of the m Break contacts element(s) shall be closed		N/A
	While any of the m Break contact element(s) is closed, none of the n Make contacts element(s) shall be closed		N/A
L.8	Tests		N/A
	Clause 8 applies with following addition:		N/A
L.8.4.	Special test for mechanically linked contact elements		N/A
	This special test shall be carried out on a sample of (m+n) products where m is the number of break contacts elements and n is the number of make elements		N/A
	A different sample is used for each test		N/A
	The test shall be carried out on products in new and clean condition		N/A
	The test procedure shall be as follows:		N/A
	a) test of NC contact:		N/A
	1) the NC contact elements shall be maintained in the closed position e.g. by welding or gluing each point of contact (e.g. for double breaking contact, welding is done at the two contact points) The thickness of welding or gluing shall be such that the distance between contacts is not modified by more than 0,02 mm		N/A
	2)an actuating force shall be applied by energizing the operating coil at 110 % of its rated voltage		N/A
	3) while applying the force, an impulse test voltage of 2,5 kV (1,2/50 $\mu$ s at sea level; correction should be made according to table 12 of IEC60947-1 shall be applied across every NC contact. There shall be no disruptive discharge		N/A
	b) test of NO contact:		N/A
	1) the NO contact elements shall be maintained in the closed position e.g. by welding or gluing each point of contact (e.g. for double breaking contact, welding is done at the two contact points) The thickness of welding or gluing shall be such that the distance between contacts is not modified by more than 0,02 mm		N/A
	2)an actuating force shall be applied by de-energizing the operating coil		N/A



## TEST REPORT

Report. No.: TCT-TR01-221125-7

Date: 2022-11-25

Page: 49 of 61 pages



	3) while applying the force, an impulse test voltage of 2,5 kV (1,2/50 $\mu$ s at sea level; correction should be made according to table 12 of IEC60947-1 shall be applied across every NO contact. There shall be no disruptive discharge		N/A
--	---	--	-----

<b>Annex M</b>	<b>TERMINAL MARKING, DISTINCTIVE NUMBER AND DISTINCTIVE LETTER FOR CONTROL CIRCUIT DEVICES</b>		N/A
M.1	General		N/A
	This annex applies to control switches and contactor relays irrespective of their construction, having terminal marking.		N/A
M.2	Terminal marking rule		N/A
M.2.1	General		N/A
	Terminal marking in accordance with this annex is based, in principle, on a two-digit number.		N/A
M.2.2	Function digit		N/A
	Sub clause L.3.2.1 of IEC 60947-1 applies.		N/A
M.2.3	Sequence digit		N/A
	The tens digit is a continuous sequence number beginning with 1 (except for control switches designated 01 and contactor relays designated 01E), independent of the contact function		N/A
	Terminals belonging to the same contact are marked with the same sequence digit.		N/A
	For contactor relays having 10 contact elements, the sequence digit 0 is used instead of 10.		N/A
	The sequence digit may be omitted from the terminal marking only if additional information provided by the manufacturer or the user clearly gives such digit.		N/A
M.2.4	Numbering method		N/A
	The contact terminals shall be numbered sequentially from left to right on the device; for devices with tiers of terminals, the numbering shall begin with the tier nearest to the mounting level.		N/A
M.3	Distinctive number distinctive letter		N/A
M.3.1	General		N/A
	The quantity and type of the contact elements of a control switch according to this annex are indicated by a distinctive number. Contacts of contactor relays are indicated by a distinctive number followed by a distinctive letter.		N/A
M.3.2	Distinctive number		N/A

## TEST REPORT

Report. No.: TCT-TR01-221125-7

Date: 2022-11-25

Page: 50 of 61 pages



	The first digit of the distinctive number gives the quantity of make contact elements and the second digit the quantity of break contact elements. The third digit, if any, shall give the quantity of change-over contact elements in control switches.		N/A
M.3.3	Distinctive letter		N/A
	The distinctive letter indicates the location of the contact elements of a contactor relay in relation to each other and their terminal marking.		N/A
M.4	Terminal numbering sequence		N/A
	For control switches having the same distinctive number, the terminal marking is specified in Table M.1.		N/A
	The position of the contact elements of the control switch need not correspond to that shown on diagrams of Table M.1.		N/A
M.5	Contactor relays designated by the distinctive letter E		N/A
	For contactor relays having the same distinctive number and the distinctive letter E, independently of their construction, the sequence of the contact elements within the device is specified in accordance with the diagrams of Table M.2.		N/A
M.6	Contactor relays designated by the distinctive letter X, Y or Z		N/A
M.6.1	Contactor relays designated by the distinctive letter Z		N/A
	If the location of the contact elements within the device (but not the terminal marking) differs from the provisions of Clause M.5, the device shall be designated by the distinctive letter Z instead of the distinctive letter E.		N/A
M.6.2	Contactor relays designated by the distinctive letter X		N/A
	If the location of the contact elements within the device and the terminal marking both differ from the requirements of Clause M.5, the device shall be designated by the distinctive letter X instead of the distinctive letter E.		N/A
	The device shall comply with the requirements of Clauses M.2 and M.3.		N/A
M.6.3	Contactor relays designated by the distinctive letter Y		N/A
	Devices consisting of combinations of contact elements and terminal marking in accordance with Table M.3 shall be designated by the distinctive letter Y instead of the distinctive letter E.		N/A
<b>Annex N</b>	<b>Procedure to determine reliability data for electromechanical devices in control circuits used in functional safety applications</b>		N/A
N.3	Method based on durability test results		N/A
N.3.1	General method		N/A

## TEST REPORT

Report. No.: TCT-TR01-221125-7

Date: 2022-11-25

Page: 51 of 61 pages



	K.3.1 of IEC 60947-1:2007/AMD2:2014 applies.		N/A
N.3.2	Test requirements		N/A
N.3.2.1	General		N/A
	The test environment shall be in accordance with Clause 6.		N/A
	Every test shall be performed under the general conditions stated in 8.3.2.1 and at a rate equal or higher at the discretion of the manufacturer. The moving parts of the device shall reach their maximum operating positions in both directions, as recommended by the manufacturer. Reliability data to be published are described in Clause N.4.		N/A
N.3.2.2	Mechanical durability		N/A
	The mechanical durability of a control circuit device is defined as the number of no-load operating cycles. For the no-make current or no-break current utilization the mechanical durability is applicable.		N/A
	During the test, periodically the contacts shall be checked at any voltage and current, selected by the manufacturer, and there shall be no failure.		N/A
N.3.2.3	Electrical durability		N/A
	The electrical durability of a control circuit device is defined as the number of on-load operating cycles.		N/A
	Electrical durability shall be determined in accordance with C.3.2 using utilization category AC-15 and / or DC-13 unless otherwise stated by the manufacturer.		N/A
N.3.3	Number of samples		N/A
	K.3.3 of IEC 60947-1 applies with the following addition:		N/A
	The selection of samples to be tested for a series of devices with same fundamental design and without significant difference in construction shall be based on engineering judgment.		N/A
N.3.4	Characterization of a failure mode		N/A
	K.3.4 of IEC 60947-1 applies		N/A
N.3.5	Weibull modelling		N/A
	K.3.5 of IEC 60947-1 applies		N/A
N.3.6	Useful life and upper limit of failure rate		N/A
	K.3.6 of IEC 60947-1 applies		N/A
N.3.7	Reliability data		N/A
	K.3.7 of IEC 60947-1 applies		N/A
N.4	Data information		N/A
	K.4 of IEC 60947-1 applies		N/A
N.5	Example		N/A
	K.5 of IEC 60947-1 applies		N/A

# TEST REPORT



Report. No.: TCT-TR01-221125-7  
 Date: 2022-11-25  
 Page: 52 of 61 pages

<b>8.3.3.3</b>	<b>TABLE: Heating Test</b>			<b>P</b>
	<b>Test voltage (V)</b> .....	220 V a.c.		—
	<b>Ambient (°C)</b> .....	23.1		—
Thermocouple Locations		Max. temperature measured, (°C / K)	Max. temperature limit, (K)	
5. Primary Winding (T1)		54.6 / 31.5	81.9 (105-23.1)	
6. Secondary Winding (T1)		54.7 / 31.6	81.9 (105-23.1)	
7. Plastic Bobbin (T1)		54.0 / 30.9	-	
8. Capacitor (EC1)		59.2 / 36.1	61.9 (85-23.1)	
9. Semiconductor (L1)		51.6 / 28.5	-	
10. Internal Winding		44.3 / 21.2	56.9 (80-23.1)	
11. Lamp Holder (WHT)		53.6 / 30.5	-	
13. LED Module PC Cap (WHT)		52.6 / 29.5	-	
14. Lamp Holder Housing (WHT)		48.1 / 25.0	-	
15. Film Type of Buzzer Capacitor		36.3 / 13.2	-	
16. Buzzer Tentel Capacitor		37.6 / 14.5	61.9 (85-23.1)	
17. Bottom Body		33.8 / 10.7	50	
18. Lamp Lens (Center)		32.6 / 9.5	50	
Supplementary information:				

	<b>TABLE: Heating test, resistance method</b>					<b>N/A</b>
	<b>Test voltage (V)</b> .....					—
	<b>Ambient, t<sub>1</sub> (°C)</b> .....					—
	<b>Ambient, t<sub>2</sub> (°C)</b> .....					—
Temperature rise of winding	R <sub>1</sub> (Ω)	R <sub>2</sub> (Ω)	ΔT (K)	Max. dT (K)	Insulation class	
Supplementary information:						

<b>8.3.3.4</b>	<b>TABLE: Dielectric Strength</b>			<b>P</b>
<b>Test voltage applied between:</b>		<b>Test potential applied (V)</b>	<b>Breakdown / flashover (Yes/No)</b>	
Accessible part and cable terminations		1 500 V d.c.	No	
Supplementary information:				

<b>7.1.3</b>	<b>TABLE: Clearance And Creepage Distance Measurements</b>					<b>P</b>
clearance cl and creepage distance dcr at/of:	Up (V)	U r.m.s. (V)	Required cl (mm)	cl (mm)	required dcr (mm)	dcr (mm)
Accessible and live parts	-	220 V a.c.	5	5.7	5	5.7
Supplementary information:						

# TEST REPORT

Report. No.: TCT-TR01-221125-7  
 Date: 2022-11-25  
 Page: 53 of 61 pages



TABLE: Distance Through Insulation Measurements				N/A
Distance through insulation di at/of:	U r.m.s. (V)	Test voltage (V)	Required di (mm)	di (mm)
Supplementary information:				

TABLE: Needle- flame test (NFT)					N/A
Object/ Part No./ Material	Manufacturer/ trademark	Duration of application of test flame (ta); (s)	Ignition of specified layer Yes/No	Duration of burning (tb) (s)	Verdict
Supplementary information: <b>NFT not relevant (or applicable) for Parts of material classified as V-0 or V-1</b> <b>NFT not relevant (or applicable) for Base material of PCBs classified as V-0 or if relevant VTM-0</b>					

TABLE: Resistance to heat and fire - Glow wire tests								N/A
Object/ Part No./ Material	Manufacturer / trademark	Glow wire test (GWT); (°C)						Verdict
		550	650		750		850	
			te	ti	te	ti		
Object/ Part No./ Material	Manufacturer / trademark	Glow-wire flammability index (GWFI), °C				GW ignition temp. (GWIT), °C		Verdict
		550	650	750	850	675	775	
The test specimen passed the glow wire test (GWT) with no ignition [(te – ti) ≤ 2s] (Yes/No) :								
If no, then surrounding parts passed the needle-flame test of annex E (Yes/No)..... :								
The test specimen passed the test by virtue of most of the flaming material being withdrawn with the glow-wire (Yes/No)? ..... :								
Ignition of the specified layer placed underneath the test specimen (Yes/No)..... :								
Supplementary information: 550 °C GWT not relevant (or applicable) to parts of material classified at least HB40 or if relevant HBF The GWIT pre-selection option, the 850 °C GWFI pre-selection option, and the 850 °C GWT are not relevant (or applicable) for attended appliances.								

# TEST REPORT

Report. No.: TCT-TR01-221125-7

Date: 2022-11-25

Page: 54 of 61 pages



TABLE: Critical components information					P
Object / part No.	Manufacturer / trademark	Type / model	Technical data	Standard	Mark(s) of conformity <sup>1)</sup>
Internal Wiring	Hae Kwang Cable	1007	Extruded PVC; 22 AWG for each LED layer; 20 AWG for common conductor	UL 758	UL (E300577)
Flexible heat shrinkable polyolefin tubing	LS Cable & System Ltd	GSHS-1625G	600 V, 125 °C, VW-1	UL 224	UL (E84393)
Body Cap	LG Chemical Ltd	HF-380	ABS, HB	UL 94	UL (E67171)
Lens Body, LED Base, LED Cap	Samyang Corporation	3022IR	PC, V-2	UL 94	UL (E121254)
LED Lamp-Socket Holder	LG Chemical Ltd	AF312	ABS, V-0	UL 94	UL (E67171)
PCB	Doosan Corporation Electro-Materials BG	DS-1107A	V-0, 130 °C	UL 94	UL (E103670)
LED Lamp Socket (Bayonet Type)	KG Auto Controls Co., Ltd.	TL-PS-001	B14, galvanized	EN 60947-5-1	Tested in the EUT
Transformer (T1)	Jun Sung Electronics Co.	EI 28x11	CL. "A"	EN 60947-5-1	Tested in the EUT
Transformer Bobbin (T1)	Hyundai Bobbin Co. Ltd.	28*11	PBT	EN 60947-5-1	Tested in the EUT
Supplementary information:					
1) Provided evidence ensures the agreed level of compliance. See OD-CB2039.					

# TEST REPORT



Report. No.: TCT-TR01-221125-7

Date: 2022-11-25

Page: 55 of 61 pages

## List of test equipment used:

A completed list of used test equipment shall be provided in the Test Reports when a Manufacturer Testing Laboratory according to CTF stage 1 or CTF stage 2 procedure has been used.

Note: This page may be removed when CTF stage 1 or CTF stage 2 are not used. See also clause 4.8 in OD 2020 for more details.

Clause	Measurement / testing	Testing / measuring equipment / material used, (Equipment ID)	Range used	Last Calibration date	Calibration due date

## Statement of Measurement Uncertainty

The Test Report shall include a statement concerning the uncertainty of the measurement systems used for the tests conducted when it is required by the standard, client or other authorities.

In such cases, the table below is to be used for reporting U of M.

This page may be removed from the final Test Report when not required. See also clause 4.8 in OD 2020 for more details.

Clause #	Parameter/ Measurement / test method	Requirement % or k	Calculated U of M*

\*Note: Calculations leading to the reported value are on file with the NCB

# TEST REPORT

Report. No.: TCT-TR01-221125-7  
Date: 2022-11-25  
Page: 56 of 61 pages

## Appendix 1 : Block diagram

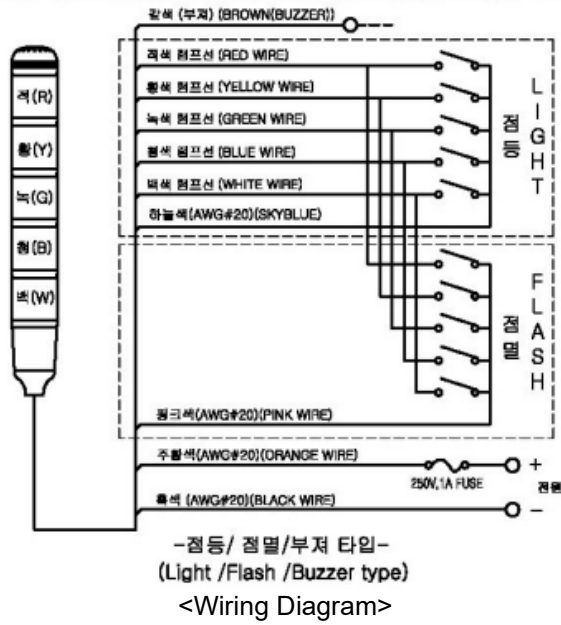



# TEST REPORT

Report. No.: TCT-TR01-221125-7  
Date: 2022-11-25  
Page: 57 of 61 pages

## Appendix 2 : Circuit Diagram

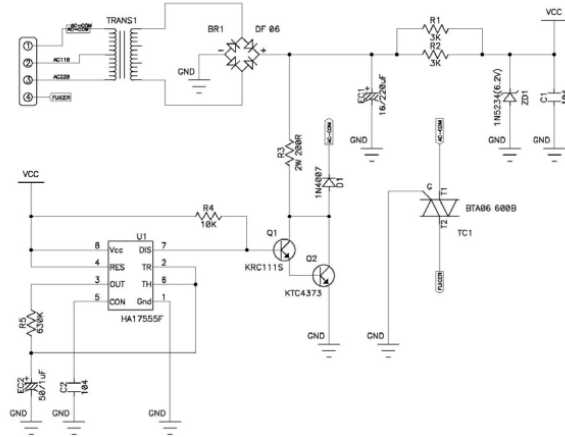

<Circuit Diagram of Main PCB>

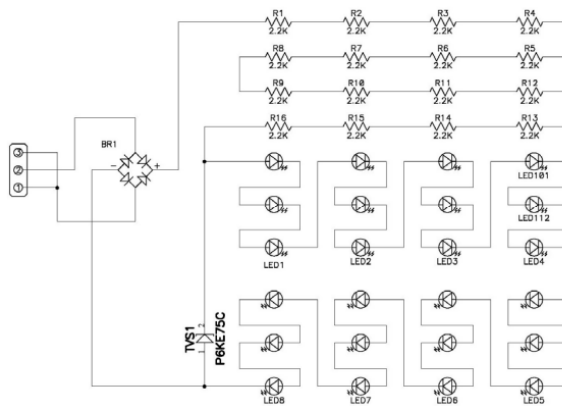

<Circuit Diagram of LED Lamps>

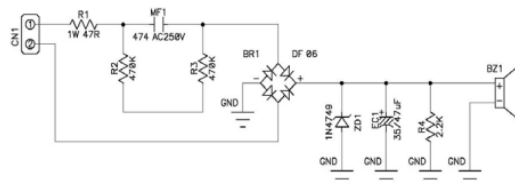

<Circuit Diagram of Buzzer>

# TEST REPORT

Report. No.: TCT-TR01-221125-7  
 Date: 2022-11-25  
 Page: 58 of 61 pages

## Appendix 3 : Layout

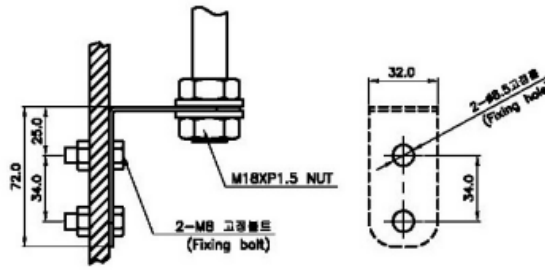

- L형 브라켓 설치용 (기본 제공) -  
 (L-type bracket installation (offerd basicly))  
 <Installation Layout>

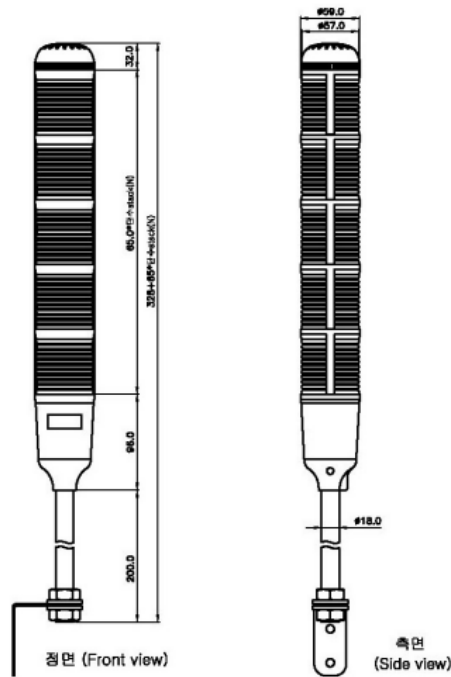

<Overall Dimension>

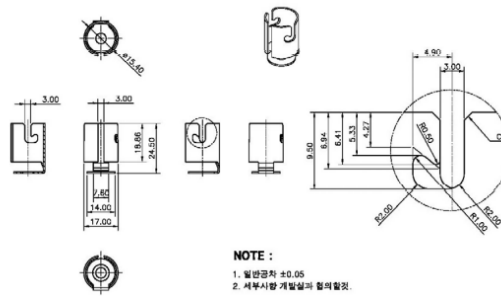

<Socket Dimension>

NOTE :  
 1. 불완공치 ±0.05  
 2. 세부사항 개량실과 일치함.

# TEST REPORT

Report. No.: TCT-TR01-221125-7  
Date: 2022-11-25  
Page: 59 of 61 pages

## Appendix 4 : Photographs

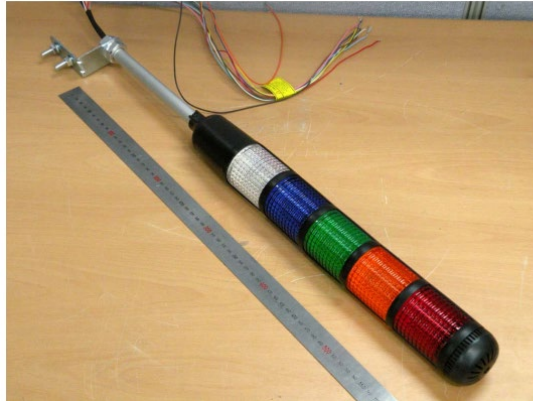

<Top View>

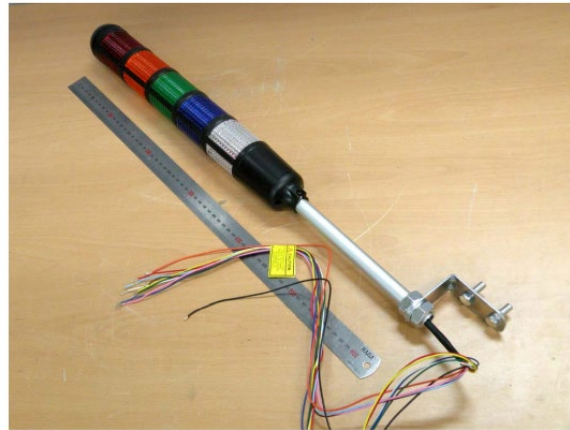

<Bottom View>

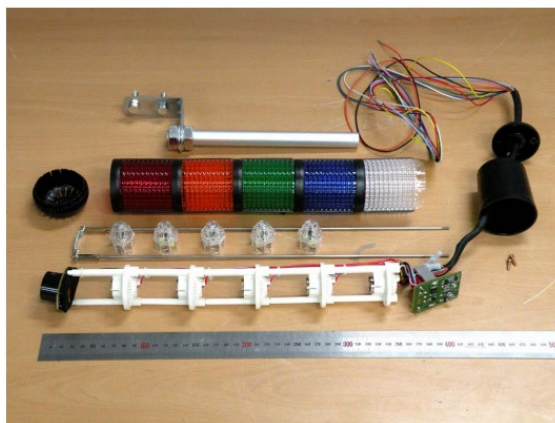

<Exploded View>

# TEST REPORT

Report. No.: TCT-TR01-221125-7  
Date: 2022-11-25  
Page: 60 of 61 pages



<LED Lamp>

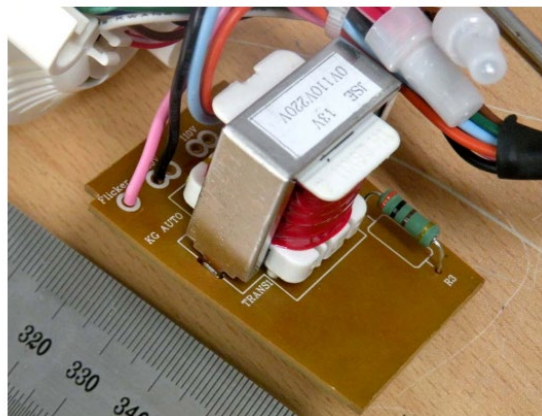

<Top View of Main PCB>

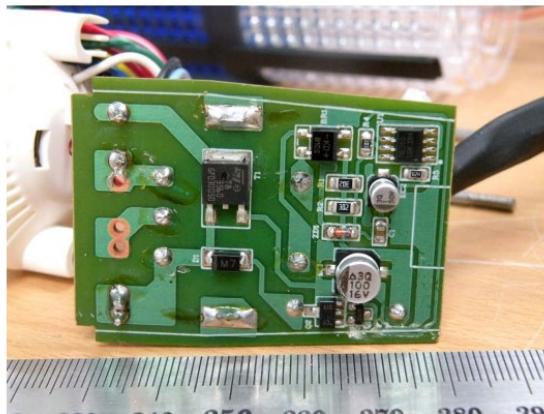

<Bottom View of Main PCB>

# TEST REPORT

Report. No.: TCT-TR01-221125-7  
Date: 2022-11-25  
Page: 61 of 61 pages

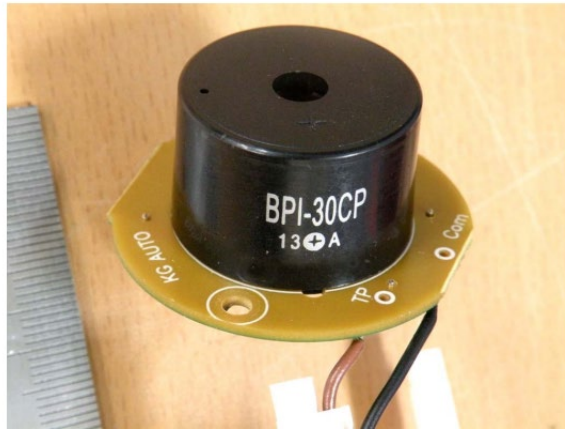

<Top View of Buzzer PCB>

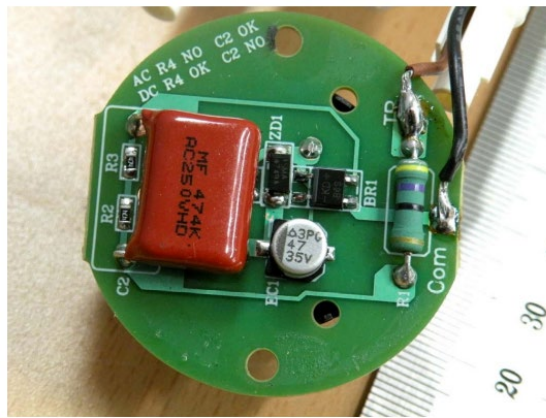

<Bottom View of Buzzer PCB>