

특징 (Features)

1. 조작부와 접점부 상·하 분리형으로 설계되었습니다.
Operating and contact part was planned in separation style
2. 취부홀 Ø16, Ø22로 설계하여 선택 사용시 용이합니다.
Attached hole Ø16, Ø22로 설계하여 선택 사용시 용이합니다
3. 슬림형은 판넬에서 2.5mm 돌출로 측면으로부터 걸림이 없습니다.
Slim type is being 2.5mm projections from panel, there is no jam from the side
4. 스냅 동작 접점 블록은 기본 1a1b로 설계되었습니다.
Contact block was planned basic 1a1b
5. 광원 출력부는 LED를 기본으로 제작되었습니다.
A light source was produced with the LED
6. SH02210-12001 CE
7. 보호구조
Protected structure : IP65

LED 램프 (LED Lamp)

1차 입력전압 (Rated voltage)	정격전류 (Rated current)
12/24V d.c	32mA
110/220V a.c	7.5mA

기본회로 (Circuit diagrams)



성능 (Performance)

종 류(Items)		KD Series 제어용 스위치(Ø16, Ø22)	
항 목(List)		250V a.c 3A	
정격용량 (Rating)		100mA이상(Min 100mA)	
절연저항 (Insulating resistance)		1,500V a.c, 50/60Hz에서 1분간(1,500V a.c, 50/60Hz 1min)	
내전압 (Withstand voltage)		50mΩ 이하	
접촉저항 (Contact resistance)		10~55Hz 복진폭 3mm(10~55Hz Vibration Width 3mm)	
내진동 (Vibration protection)		약50G(500%)	
내충격 (Shock protection)		-10℃~+50℃	
사용주위 온도 (Ambient temperature)		45~85% RH	
사용주위 습도 (Relative humidity)		최대 30회/분(Max 30/1 min)	
개폐빈도 (Open/close time)		진기적 (Electrical) 10만회 이상/1,800h(Min 0.1mil/1,800h)	
수명 (Lifetime)	전기적 (Electrical)	기계적 (Mechanical) 50만회 이상/1,800h(Min 0.5mil/1,800h)	
	기계적 (Mechanical)		

INNOVATE NOW!



조광 비상 정지용 푸쉬록턴 리셋 스위치 (Lamp emergency push lock turn reset switch)

형명 구성 (Name composition)

KDEX P 3R V2 1 R



외형 및 도면 (External form/ Drawing)

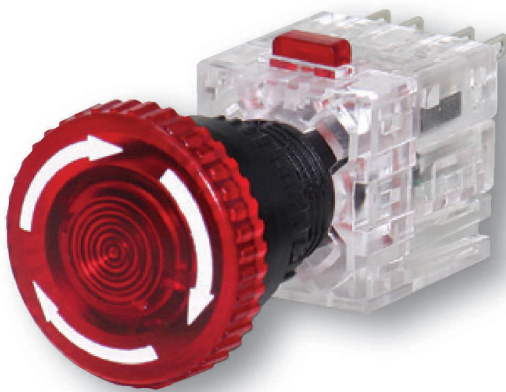

(DC/AC 타입)

원형 일반 \varnothing 16
(Round type plastic guide)

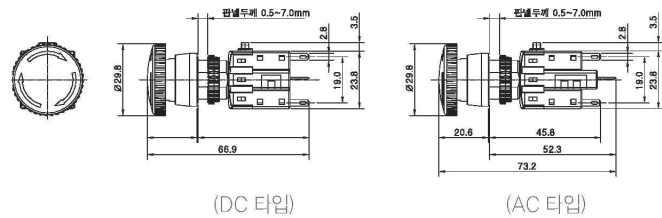

KDEX - P3RD21R(푸쉬록턴 리셋, Push lock turn reset) / 12~24V d.c
KDEX - P3RV21R(푸쉬록턴 리셋, Push lock turn reset) / 110~220V a.c

KD Series

Ø16/22 제어용 스위치

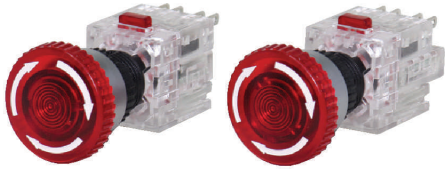

(DC 타입)

(AC 타입)

원형 고급Ø16
(Round high-grade type aluminum guide)

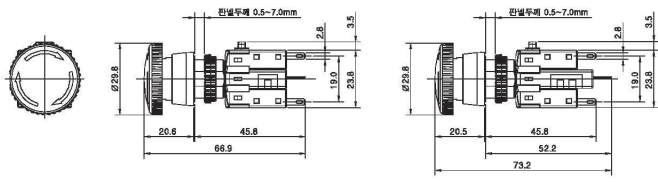

(DC 타입)

(AC 타입)

KDEX - G3RD21R (푸쉬록턴 리셋, Push lock turn reset) / 12~24V d.c
KDEX - G3RV21R (푸쉬록턴 리셋, Push lock turn reset) / 110~220V a.c

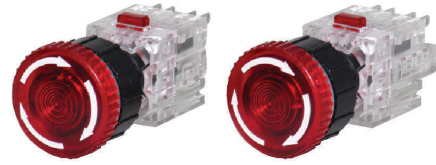

(DC 타입)

(AC 타입)

정사각 일반Ø16
(Square type plastic guide)

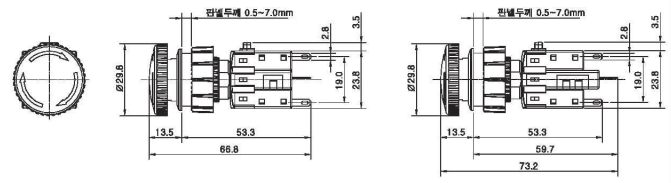

(DC 타입)

(AC 타입)

KDEX - Q3RD21R (푸쉬록턴 리셋, Push lock turn reset) / 12~24V d.c
KDEX - Q3RV21R (푸쉬록턴 리셋, Push lock turn reset) / 110~220V a.c



KD-EN16



KD-EN22(Q 타입 전용)



KD-EG16

비상 가이드
(Emergency guide)



KD-EN16



KD-EN22

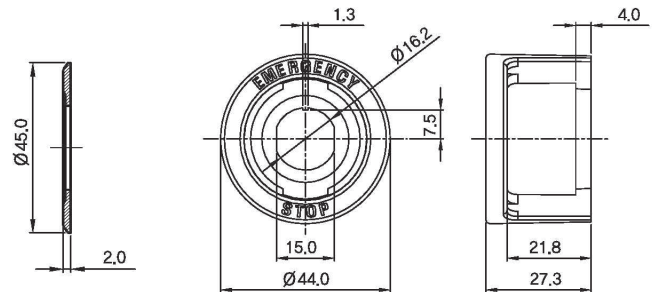

KD-EG16

Ø16 제품 조립 순서 (Assembly order)

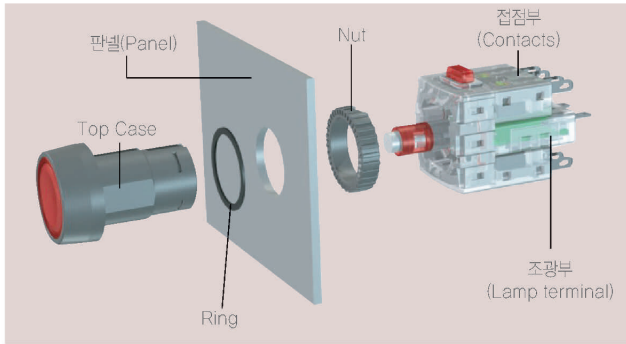

패널 가공 치수 (Panel cutting size)

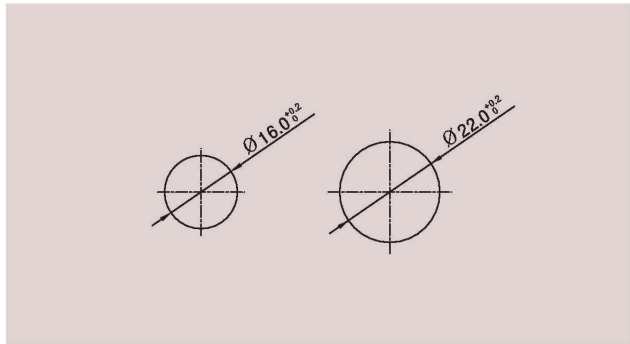

사용방법 (User guide)

●패널 연속 가공 치수 (Ø16 원형, 정사각)

(Ø16 Round, square type)

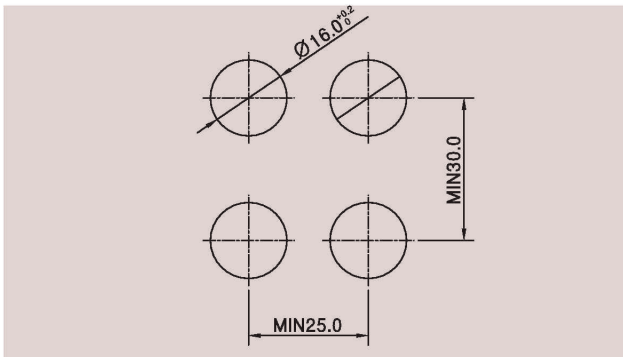

●패널 연속 가공 치수 (Ø16 직사각)

(Ø16 Rectangular type)

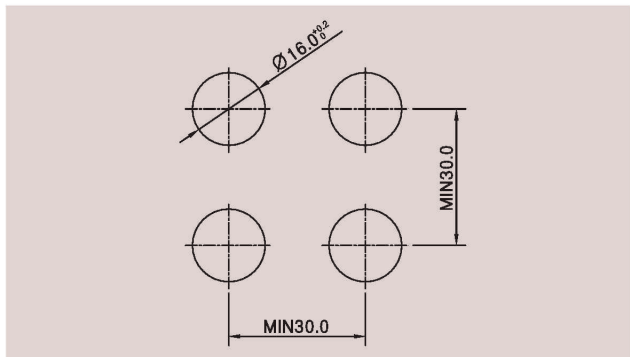

●패널 연속 가공 치수 (Ø22 슬림형)

(Ø22 Luxury buried type)

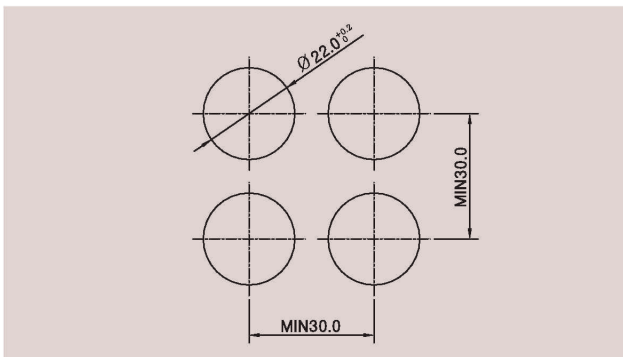

●배선 단자 터미널 (Ø16, 22)

(Ø16, 22 Contacts terminal)

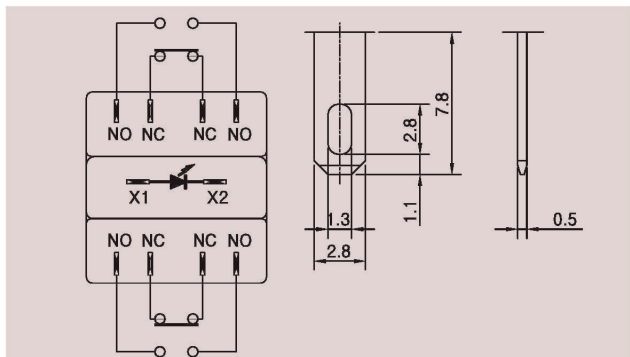

●주의사항 (Attention)

- 패널 가공은 위와 같이 필요에 따라 선택 하여 주십시오.
(Panel cutting is above by a necessity to select)
- 부착 패널의 두께는 1 ~ 7mm.
(Panel thickness 1 ~ 7mm)
- LAMP TYPE은 램프 단자와 스위치 단자의 배선이 바뀌지 않도록 주의 할 것.
(Lamp terminal and terminal wiring not to be exchange it will have attention)